



Advanced Technologies in Analytical Analysis

Mae Fah Luang University
20 Dec 2017



Sci Spec Profile

- Address : 10 Kanchanapisek Rd. Soi 0010 (2nd Junction), Bangkae, Bangkok 10160, Thailand
- Sci Spec has been established in June 2007 to sell and service of world class laboratory instrument in Thailand, Myanmar and Laos. Our business model is based on accomplishment of solutions provider and high valued long term support for laboratory instrumentation to our customers in varied field e.g. Academic Research, Environment, Food and Agriculture, Medical, Pharmaceutical, Petroleum, Petrochemicals, Forensic/Toxicology etc.

ThermoFisher
SCIENTIFIC

MARKES
international

 **FRONTIER LAB**
www.frontier-lab.com

CTC Analytics
Where design meets performance

BRECHBÜHLER
AG
SCIENTIFIC ANALYTICAL SOLUTIONS

Agena
BIOSCIENCE

 **LGC** **BIOSEARCH**
TECHNOLOGIES

Your Scientific **Specialist**

Sci Spec's Team at a glance

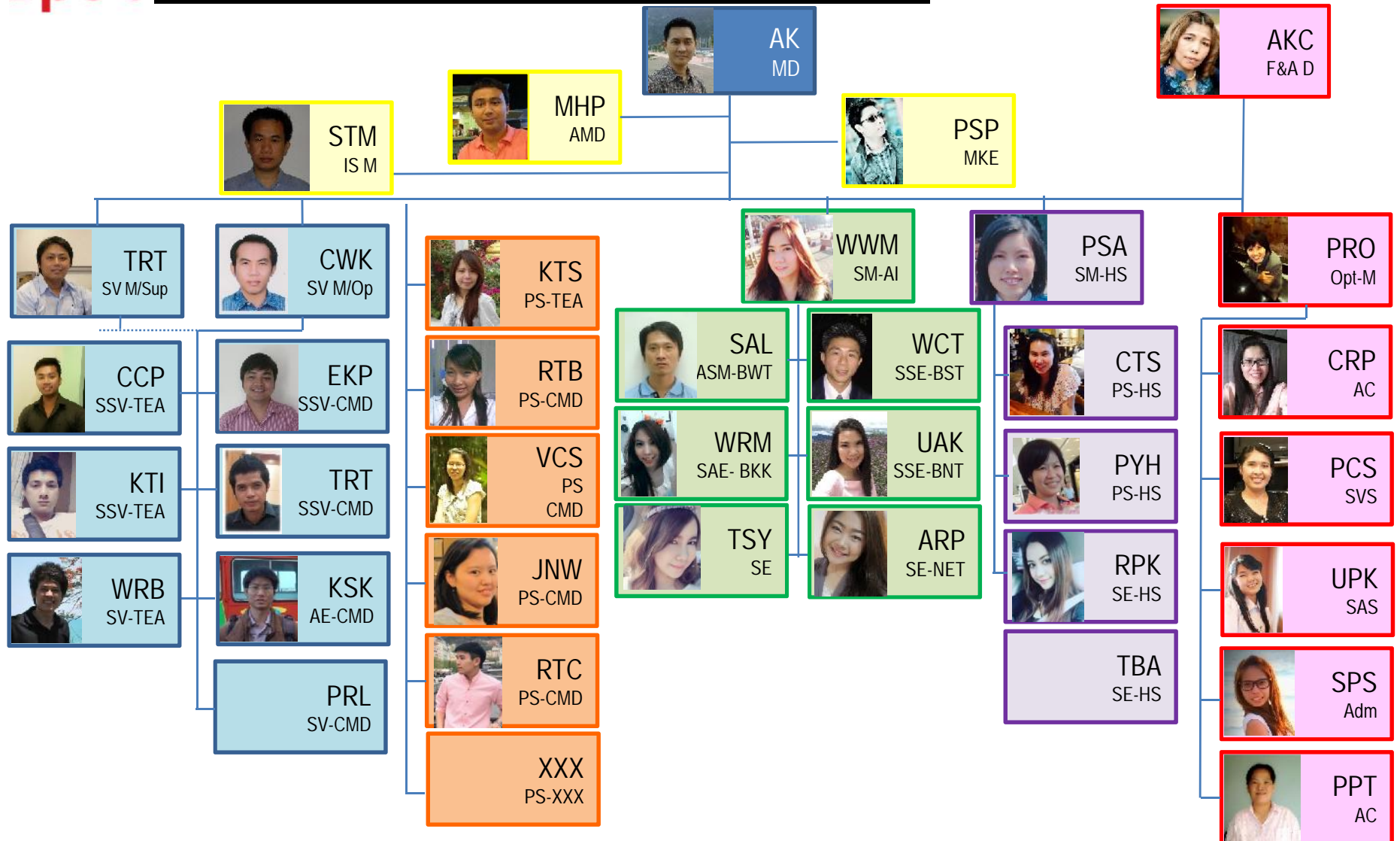

Products : Trace Elemental Analysis (TEA)

ThermoFisher
SCIENTIFIC

Performance



iCE 3500 Series AA

iCE 3300 Series AA



iCAP 7000

ICP-OES



iCAP RQ ICP-MS

iCAP TQ ICP-MSMS



ELEMENT 2,
ELEMENT XR
ICP-HRMS

Investment

Your Scientific Specialist

Organic Elemental Analyzer (CHNS-O)

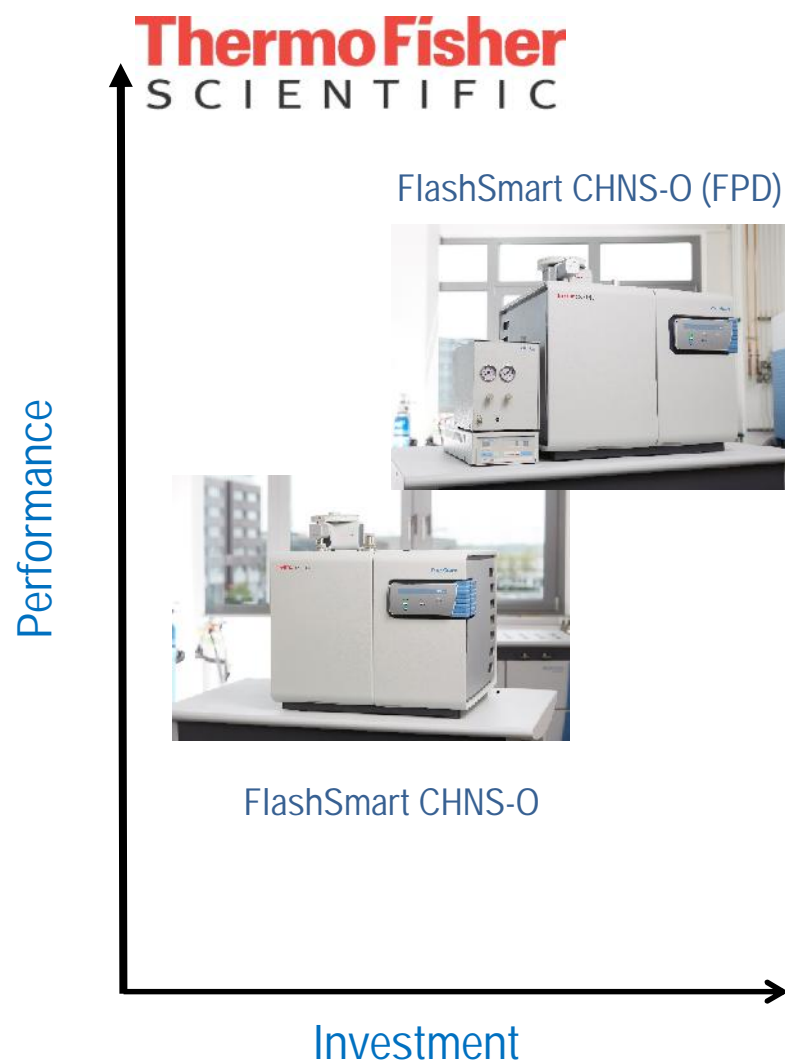

Flexible – Variety of configurations

- NC-Soil
- CHN (Single Channel)
- CHNS (Single Channel)
- CHNSO (Single Channel with MVC)
- CHN/O (Dual Channel)
- CHNS/O (Dual Channel)
- N-Organic
- NC-Organic
- NCS (Single Channel)
- CHN/CHN (Dual channel with MVC)
- CHNS/CHNS (Dual channel with MVC)



Isotope Ratio Mass Spectrometer (IRMS)

ThermoFisher
SCIENTIFIC

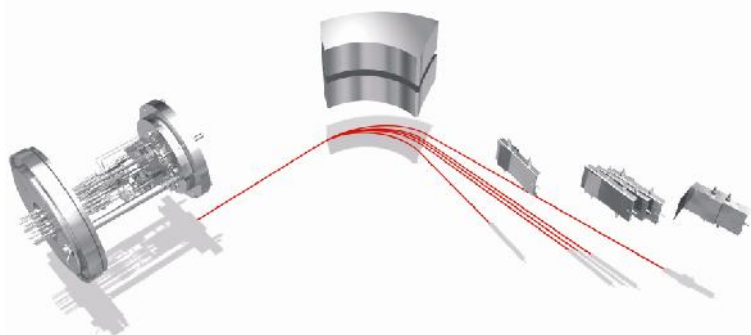

Your Scientific Specialist

LCMS solutions for all analytical challenges

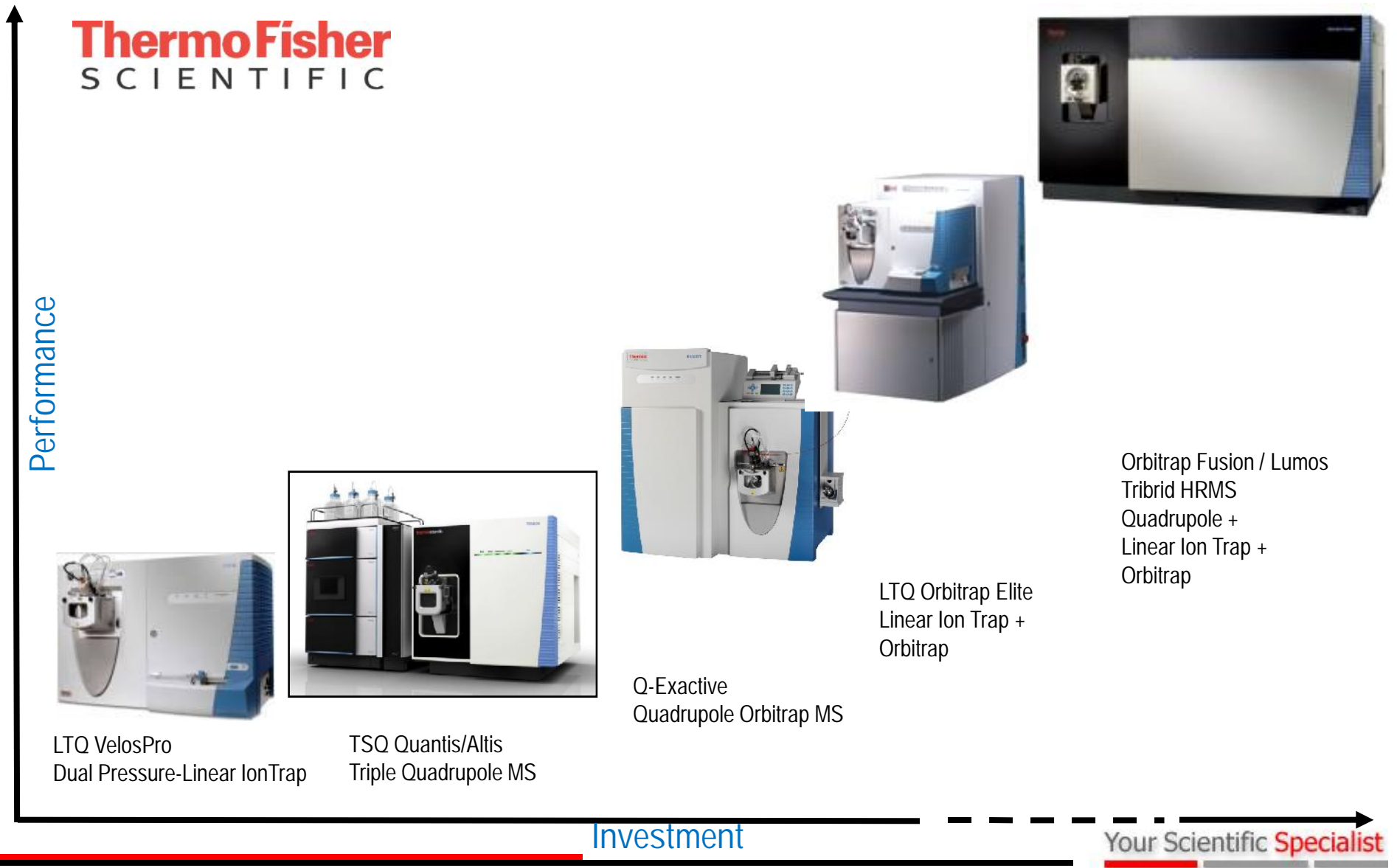



GC-MS solution for any analytical challenge

ThermoFisher
SCIENTIFIC

Performance

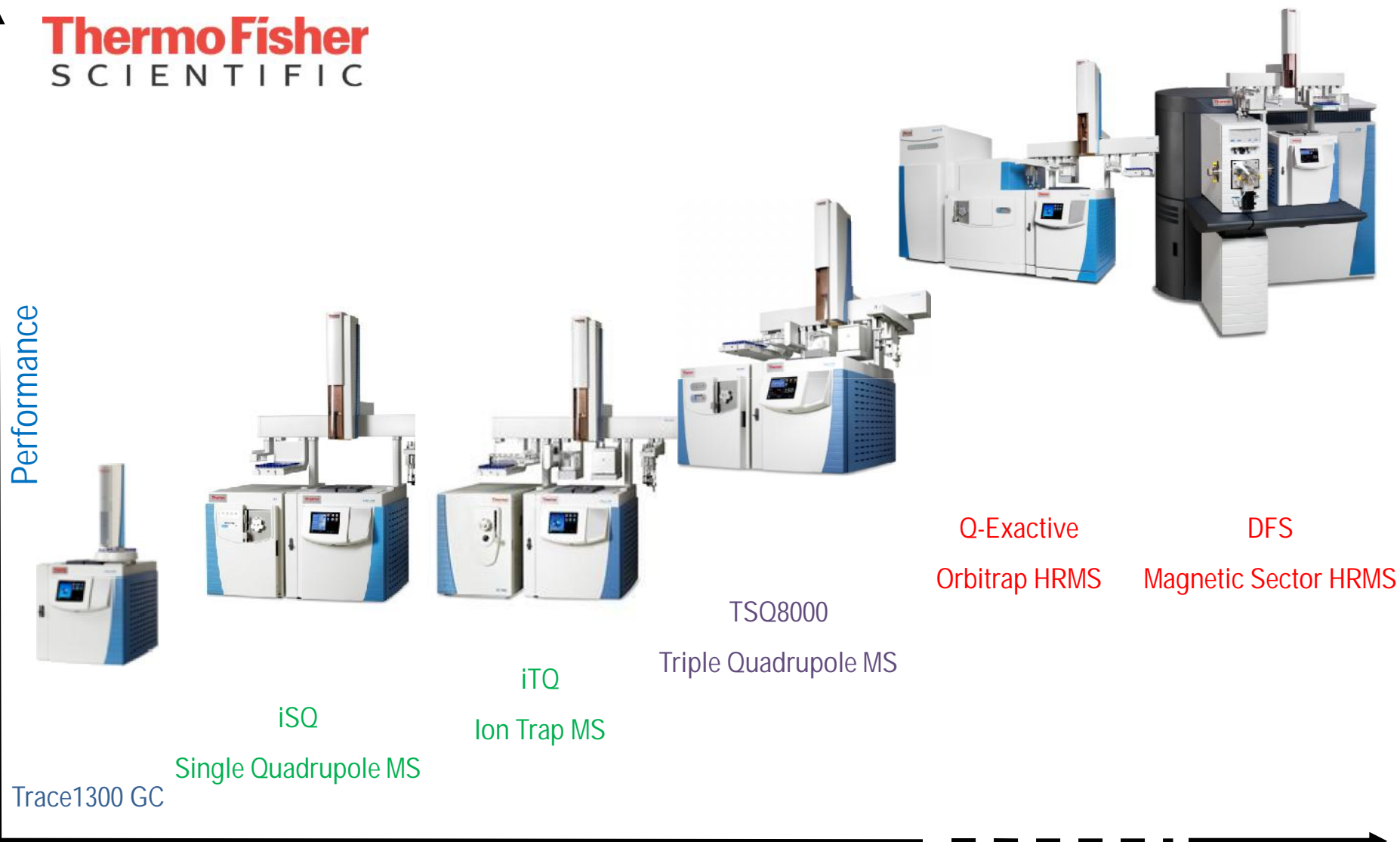

Your Scientific Specialist

Sample Prep Product Line



Thermo Scientific™ Dionex™ ASE™ 150 and 350 Accelerated Solvent Extractor



Thermo Scientific Dionex AutoTrace™ 280 Solid-Phase Extraction (SPE) Instrument



Thermo Scientific Dionex SolEx™ SPE Cartridges



Genevac Rocket™ Evaporator

LIMS for Integrated System for GMP Manufacturing

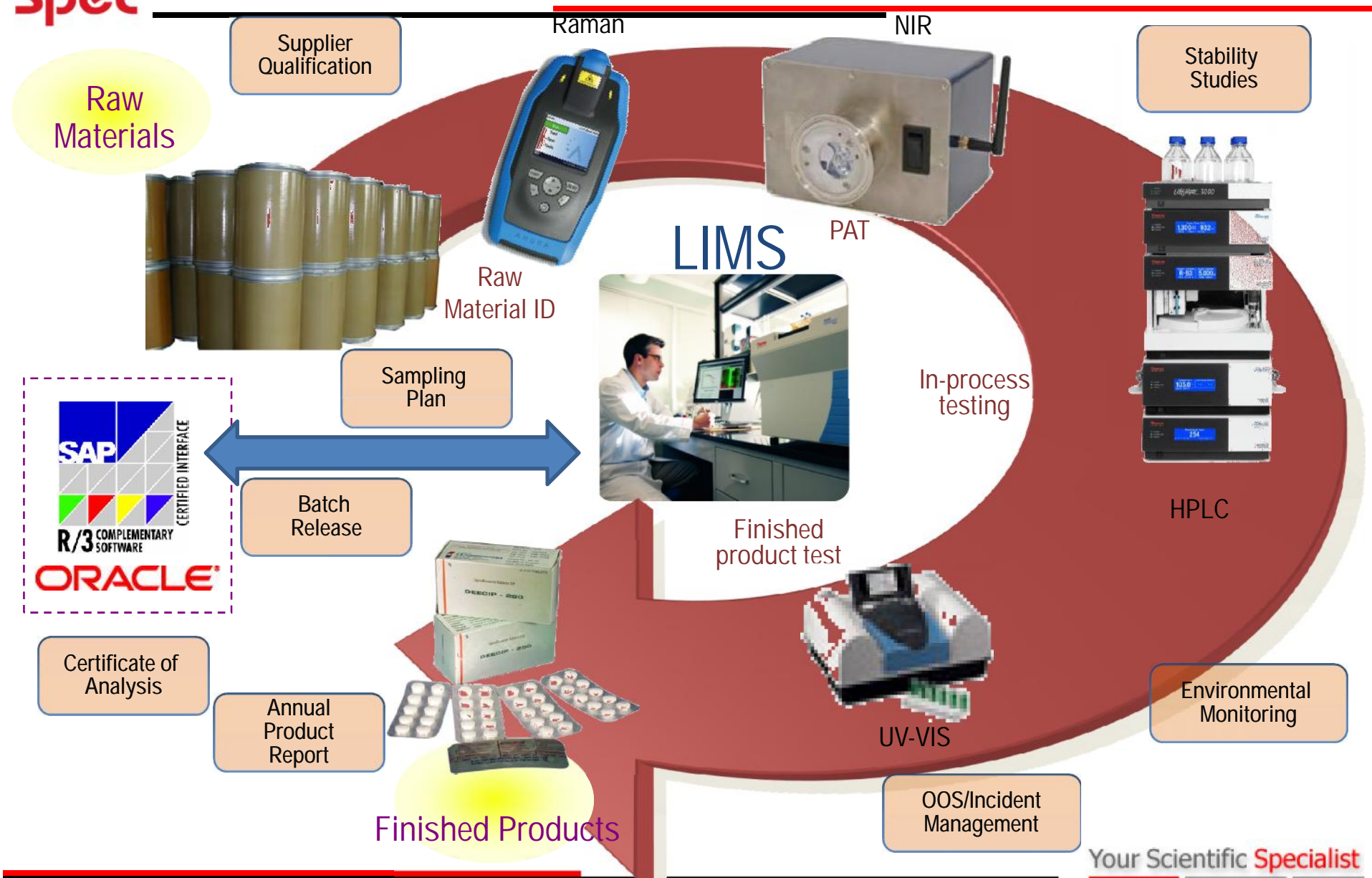

Radiation Measurement Products

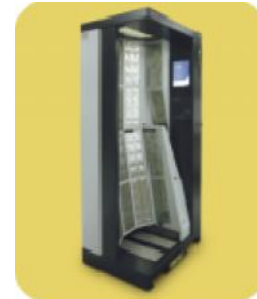
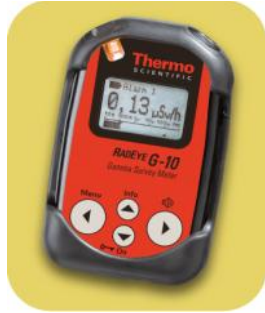

Summary:

From sample preparation to separation and analysis, we have the most comprehensive array of chromatography consumables and environmental sampling products to help our customers achieve repeatable, predictable results – separation after separation. Our comprehensive portfolio and experience in application and method development guides customers through any challenge.

Technology / Technique:

- Sample Preparation: SPE, filtration, sample storage
- Sample Handling: Vials, septum, caps and crimpers
- GC: Columns, septa, liners, ferrules, syringes
- LC: Columns for fast analytical and biomolecular separations

Industries, Markets & Applications:

- Pharmaceutical
- Government and Academia
- Environmental
- Food Safety
- Petrochemical



Thermo Scientific Product Names:

- SOLA SPE
- SureStop Vials
- TraceGOLD GC columns
- Accucore HPLC columns
- Viper Fittings

A Versatile Genomics Solution



Genotyping

Gene Expression

Copy Number Variation

Methylation

Comparative Sequence Analysis

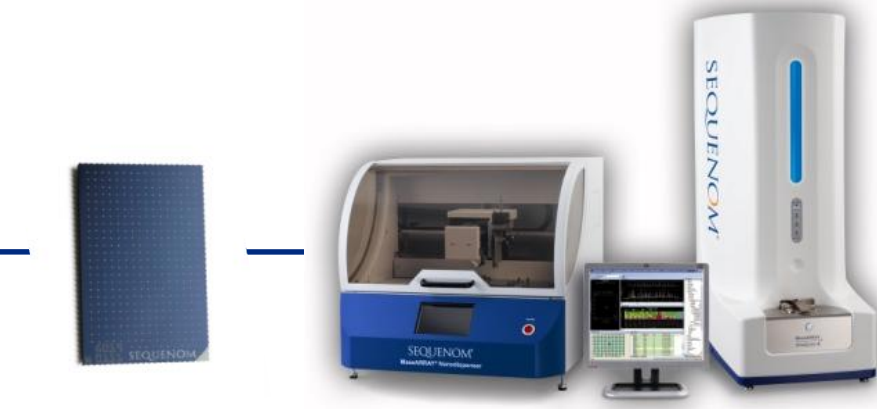

SpectroCHIP

MassArray®



Data Analysis

LGC Genomic Products



oKtopure

HT DNA Extraction



RepliKator

Automated DNA
Replicator



Dispensing



Fusion

Laser Plate Sealer



Hydrocycler

PCR Cycling



SNP Line XL

End point detection



NEXAR

HT-Array Tape PCR



IntelliQube

HT-Array Tape q-PCR



CTC Products : Prep and Load

CTC Analytics 
Where design meets performance



PAL COMBI-xt



PAL HTX-xt

World no.1 Thermal Desorption

Sorbent Tubes



Passive



Active

EPA TO-17
ISO 16000-6
ISO 16017-1 (Pumped)
ISO 16017-2 (Diffusive)



TD-100

C₃-C₄₀ & Reactive compounds

Canisters/Bags



EPA TO15



CIA Advantage

C₂ to C₁₂ & Ultra Volatile

Online

MARKES
international



2000/69/EC US Clean Air Act
NF T90-210



Unity - Air Server

C₂ to C₁₄, Sulphur cmpds, Ozone precursors

- Sorbent tubes



Tube Conditioners



EPA 325



Microchambers

ASTM D7706-11: Products
 ISO 12219-3: Auto
 VDI 2083-17: Cleanroom Materials
 ASTM D7859: SPF
 EN 16402 (Draft) Paint and varnishes
 CEN/TS 16516-2013: CPR
 ISO 16000-25: SVOC

Sampling Accessories



BenchTOF

Complementary technologies for advanced GC/MS and GCxGC/MS applications – geochemistry, odour, environmental research, ultra trace level studies and high speed operations

World Class Front-end Technology



PY3030

Pyrolyzer for GCMS



 **FRONTIER LAB**
www.frontier-lab.com

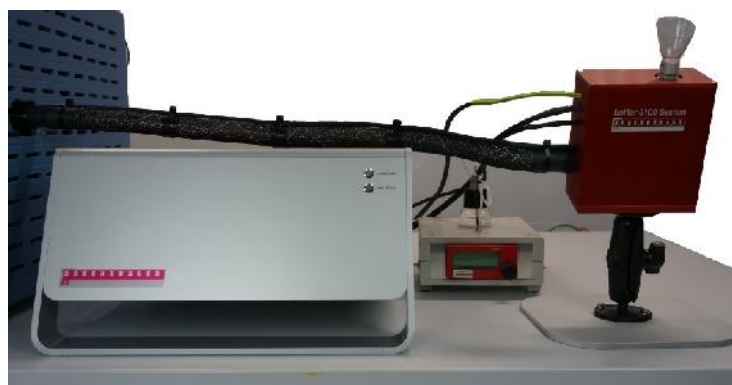

Sniffer 9100

Ofactometer for GCMS



BRECHBÜHLER
scientific analytical solutions
AG

Part of our customers in Thailand



ปูนซีเมนต์นครหลวง



Integrated Refinery & Petrochemical Complex Public Co., Ltd.



Asian Insulators
Public Company Limited



Part of our customers in Thailand



มหาวิทยาลัยนเรศวร
Naresuan University



กรมวิทยาศาสตร์บริการ
Department of Science Service

