



# Fundamental Gas Chromatograph



Ratimarth Bunlorm  
ratimarth@scispec.co.th

- Chromatography : Analytical technique that depends on separation of components in sample
- Sample components are separated and detected
- Separation : Between two phases
  - Stationary Phase
  - Mobile phase

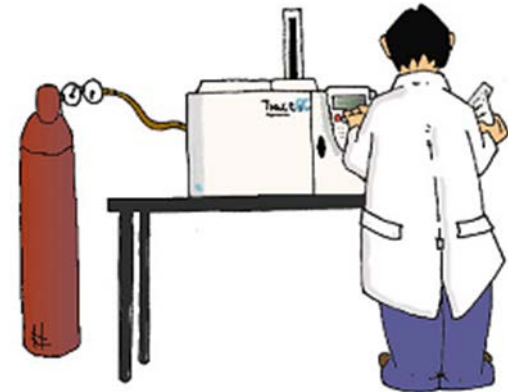

- **Adsorption** : Components of sample are adsorbed at active sites of stationary phase and are eluted (carried out) at different time based on the attractive force between stationary phase & each individual component.
- **Partition** : Components are separated based on the difference in partition ability through the stationary phase layer. Component that has better partition ability will be eluted before component that has poor partition ability to the same stationary phase

- Gas Chromatography (GC) : Chromatography technique which gas is used as mobile phase
- Sample will be injected into the system, Injection port where all components are vaporized and swept into the column
- Sample components will then be separated according to the interaction with stationary phase and eluted to detector.

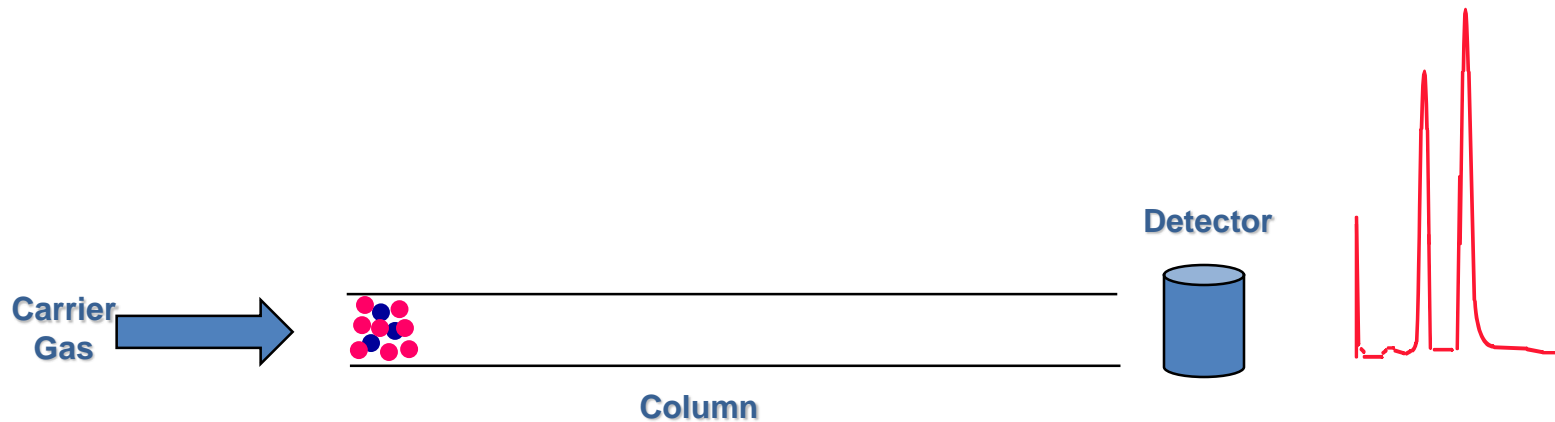

# GC System Components

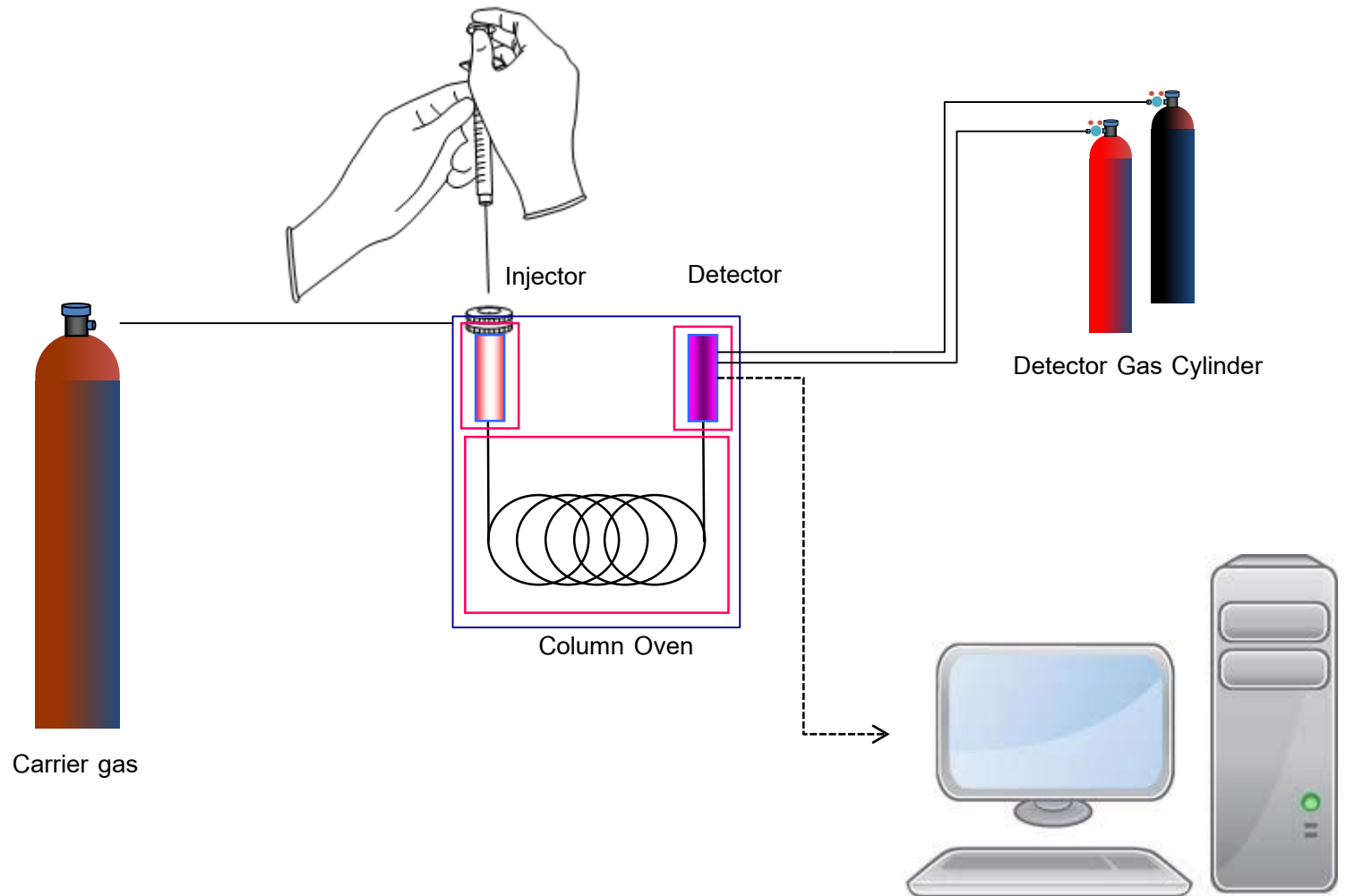

- Includes :
  - Gas Cylinder
  - Pressure Regulator
  - Tubing & Fitting
  - Purifier Traps

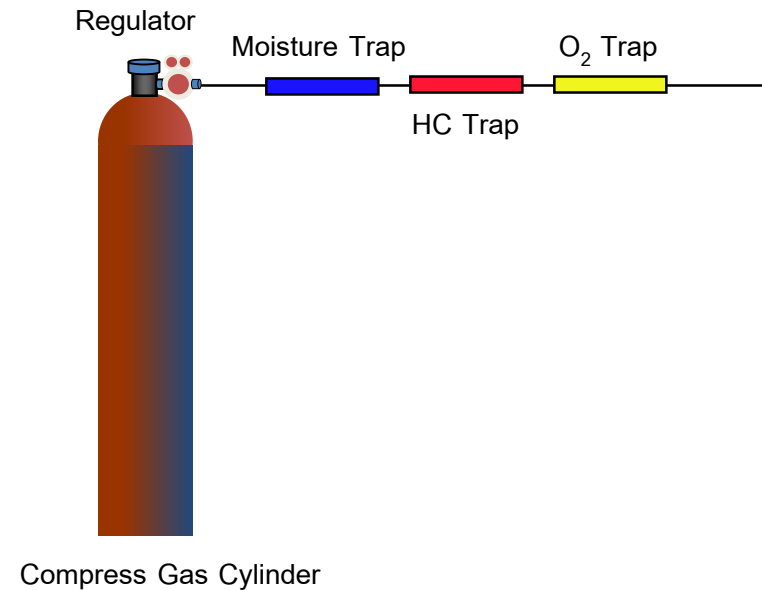

# How to select your carrier gas

---

- Type of detector and detector requirement
- Purity (Impurities) vs. Sensitivity
- Speed of Analysis & Separation Performance
- Operating Cost



- Selection of detector is limited by the type of interested components and detection limits
  - Selectivity
  - Sensitivity (Minimum Detectable Quantity)
  - Linearity (Dynamic Range)
- Detector requirement : Some detector / Analysis require specific carrier gas to provide the best analysis results ; e.g.
  - TCD : Select the carrier gas that provide the largest possible relative difference in thermal conductivity of sample & carrier gas
  - Mass Spectrometer requires Helium



- Impurities can alter stationary phase in column and cause high background (noise), contamination
  - Free from moisture, organic hydrocarbons and oxygen
  - Free from components those associate or interfere the analysis
  - Recommended at least 99.995%
  - Purified traps must be installed

- Speed of analysis : The lighter carrier gas, the faster analysis time.
  - With the same resolution (separation performance), Helium provides shorter analysis time than Nitrogen
  - Helium is lighter than Nitrogen so it travels through column faster than Nitrogen
  - At the same supplied pressure, Helium has more density than Nitrogen so Helium will provide better peak shape (resolution).

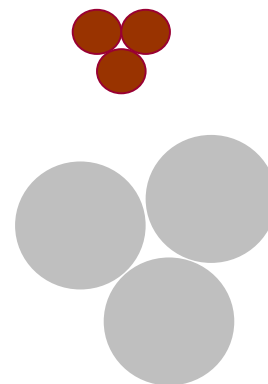
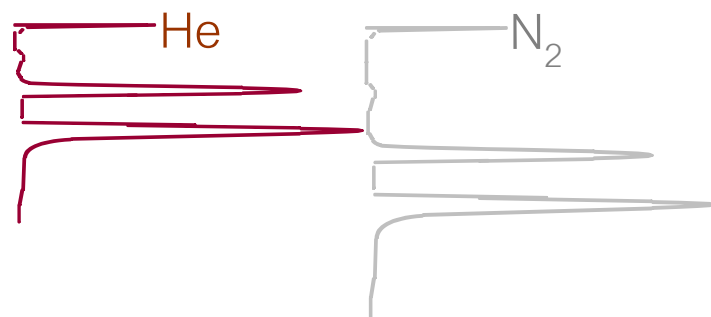

# Carrier Gas & Speed of Analysis

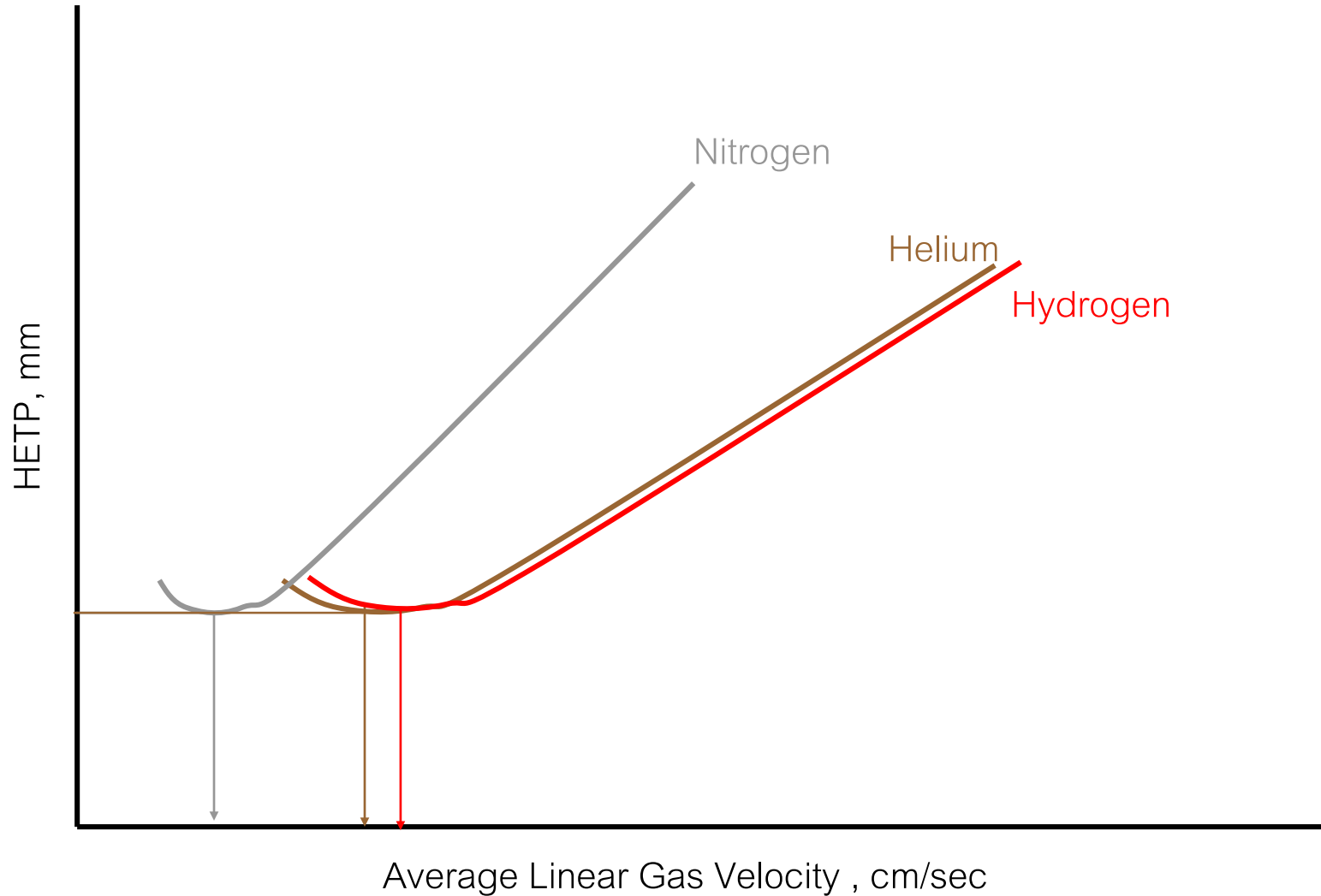

- Types :
  - Moisture
  - Hydrocarbon
  - Oxygen
  - Special purposed trap (e.g. Sulfur)
- Consideration :
  - Detection level (ppb, ppm or %)
  - Compound of interest
  - Detector Type
  - Column Type
- Replacement is required depended on
  - Quality of gas
  - Consumption
  - Contamination during cylinder changing

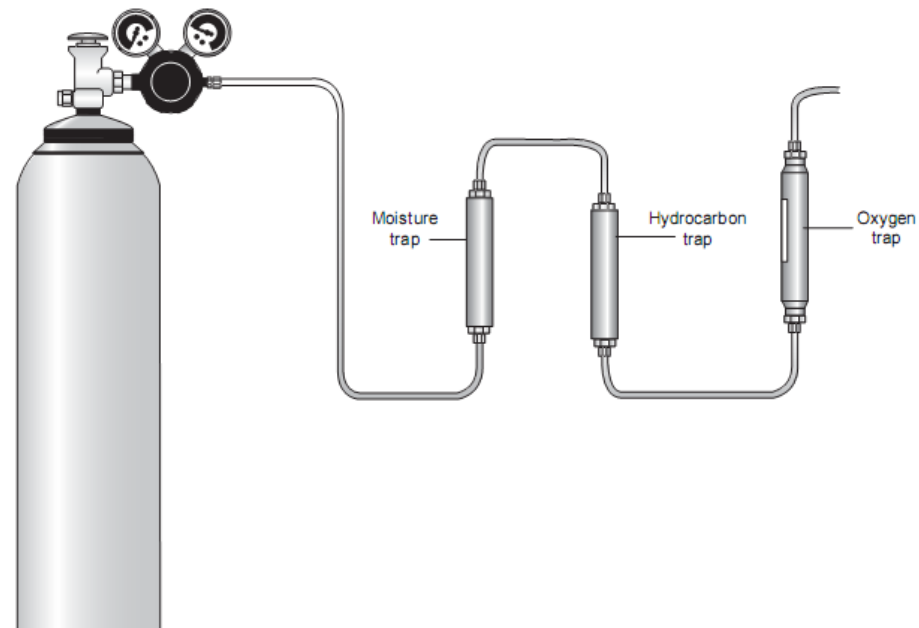

- Injector : The area in which the sample is introduced, evaporated instantaneously & carried to the column with a minimum of band spreading.
- Concerned parameters :
  - Sample size
  - Temperature
  - Carrier gas pressure/flow control

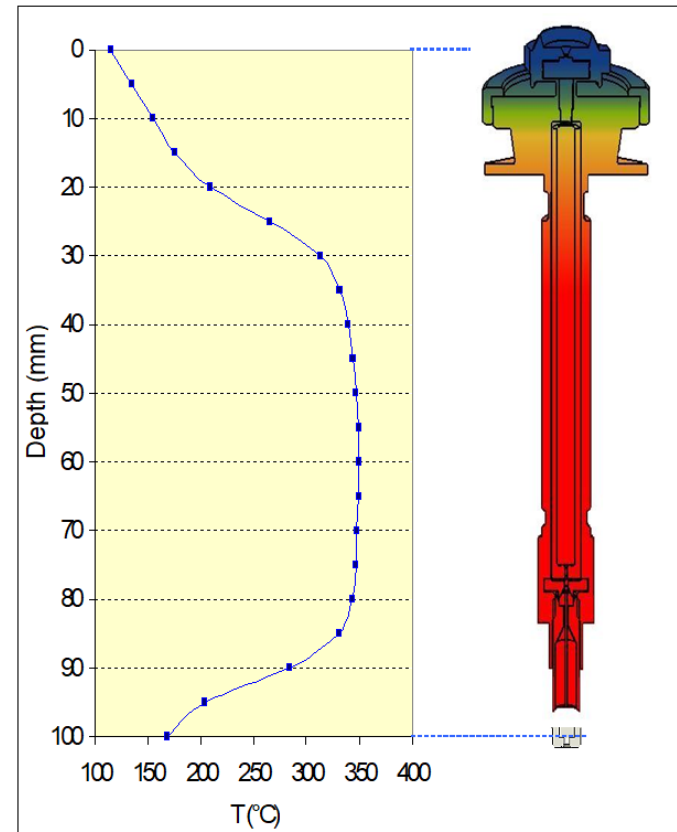

- Packed Column Injector
- Split/Splitless Injector (Capillary Injector)
- On-Column Injector
  - Packed
  - Capillary
  - Cold On-Column
- PTV : Pressure Temperature Vaporizing Injector
- Injection Valve
  - Gas Sampling Valve (GSV)
  - Liquid Sampling Valve (LSV)

- Can be used for
  - Capillary column 0.1, 0.25, 0.32 mm ID
  - Wide bore column (0.53 mm.ID)
  - Packed column (requires conversion kit)
- Can be operated in two modes
  - Split
  - Splitless



- Split Injection

- Only a part of the sample transfers into the column. The rest discharges through the split vent
- The ratio of the split flow to the column flow so called “split ratio” determines the amount of sample that enter the column

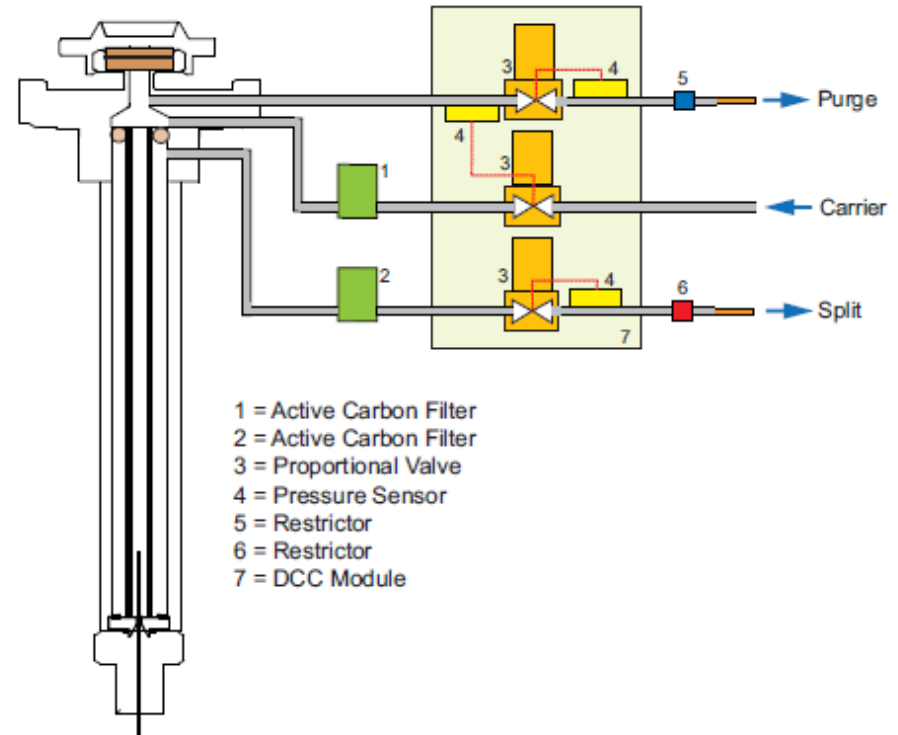



- Splitless injection is suitable for
  - The analysis of compounds present in very low concentration with relatively dirty matrices.
  - Allows a portion of entire sample to enter the column without splitting
  - Split vent is closed during sample injection and transfer to the column, Once the transfer is over, the split vent is reopened to flush the vaporizing chamber for any remaining sample vapors.

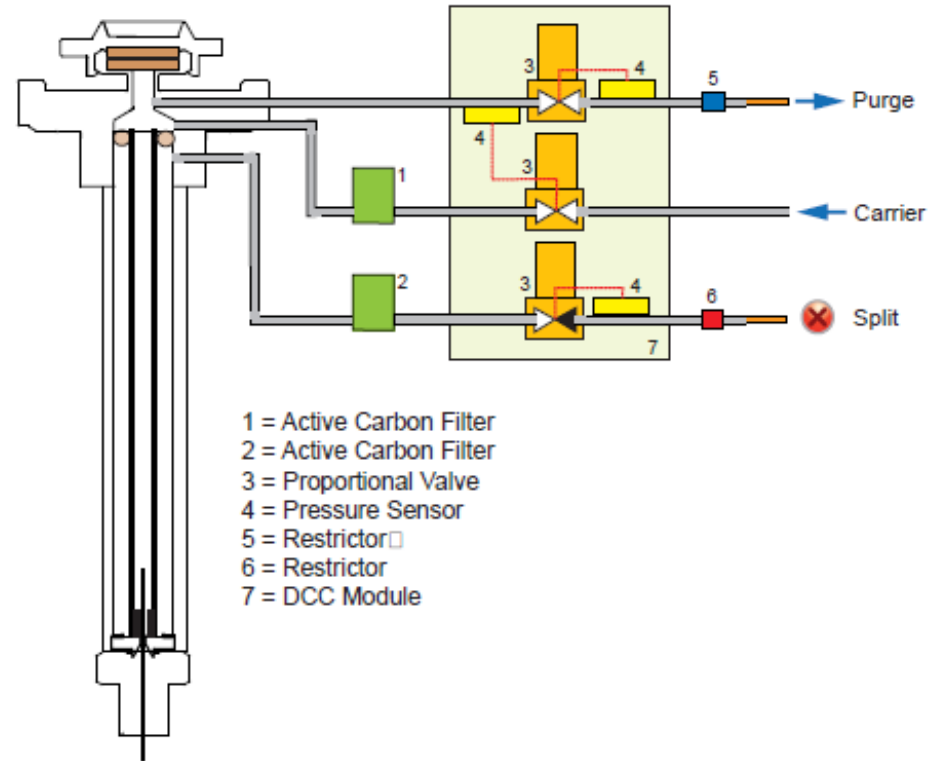

- Monitor contamination
- Set optimum injection temperature (provide complete sample vaporization)
- Inject clean sample, appropriate sample size
- Clean liner, Change liner
- Change liner seal or liner o-ring
- Change septum



- Column is used for separate components in sample.
- Good stationary phase.
  - All sample components are completely eluted (no permanent retained components)
  - Non-volatile, Thermally stable (Low bleed at high temperature)
  - Chemical inert (not react with sample and not act as catalyst)
- Classification
  - Micro-packed (1/16" OD.)
  - Packed (1/8", 1/4" OD.)
  - Wide bore (0,53 – 1.0 mm ID)
  - Narrow-bore or Capillary Column (0.1-0.32 mm. ID)

- The rule :
  - A non-polar component is dissolved in a non-polar liquid phases
  - A polar component is dissolved in a polar liquid phase.
- Elution Order of interested components vs. matrix
- Resolution : Separation Capability
- Temperature limitation of the stationary phase



- Use smaller sample size
- Lower column oven temperature
- Extend column length
- Use smaller diameter column (for capillary column)
- Use thicker stationary phase

- Provides a stable heating environment for the analytical column.
- Must heats and cools quickly with efficient air circulation to ensures a high degree of thermal stability

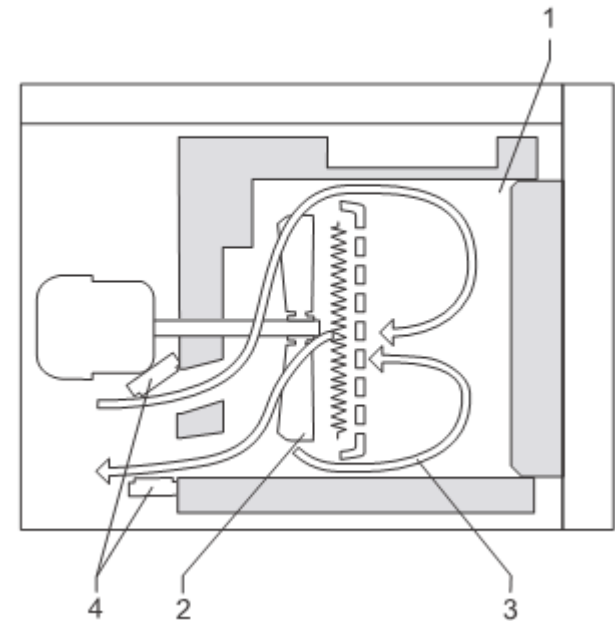

# Oven Temperature vs. Resolution

- Components in the sample will be separated under optimum column temperature
- Increases oven temperature trend to reduce in resolution
- Ultimate Goal is “all components are separated with the shortest analysis time”

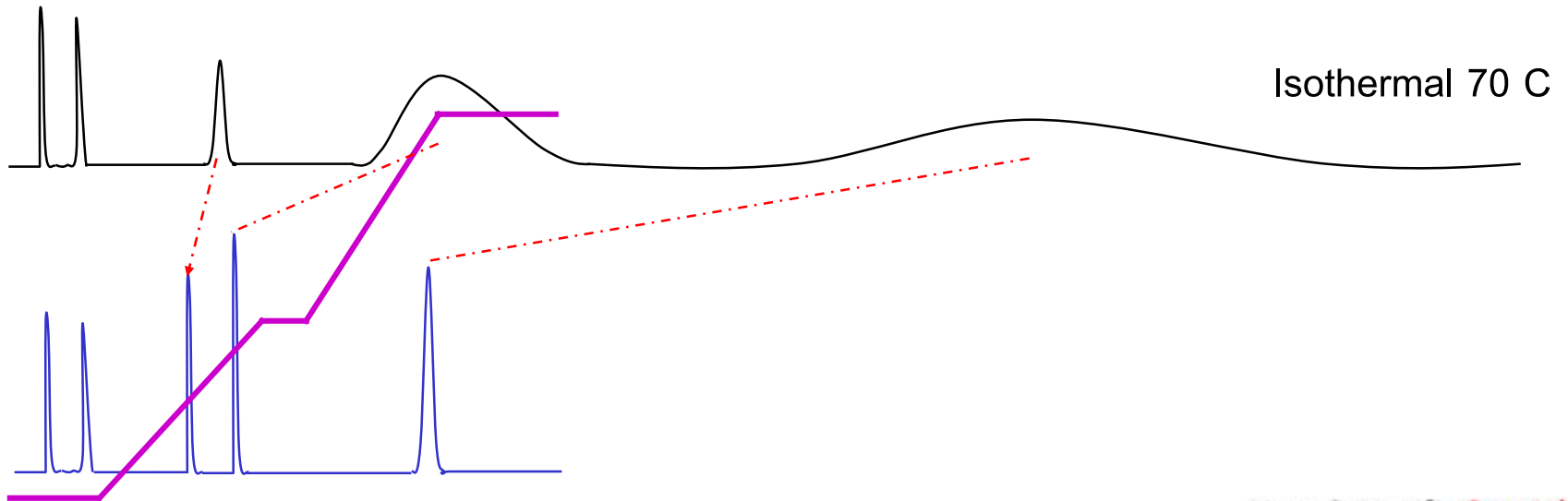

Sci  
Spec

Fundamental of Mass Spectrometer





# What is Mass Spectrometry?

---

- The production of ions that are subsequently separated or filtered according to their mass-to-charge ( $m/z$ ) ratio and detected.
- The resulting mass spectrum is a plot of the (relative) abundance of the produced ions as a function of the  $m/z$  ratio.”

# What is "Mass Spectrum" ?

- Graph of Relative Ion Intensity vs.  $m/z$
- Ion Fragments detail structure and molecular weight of compound

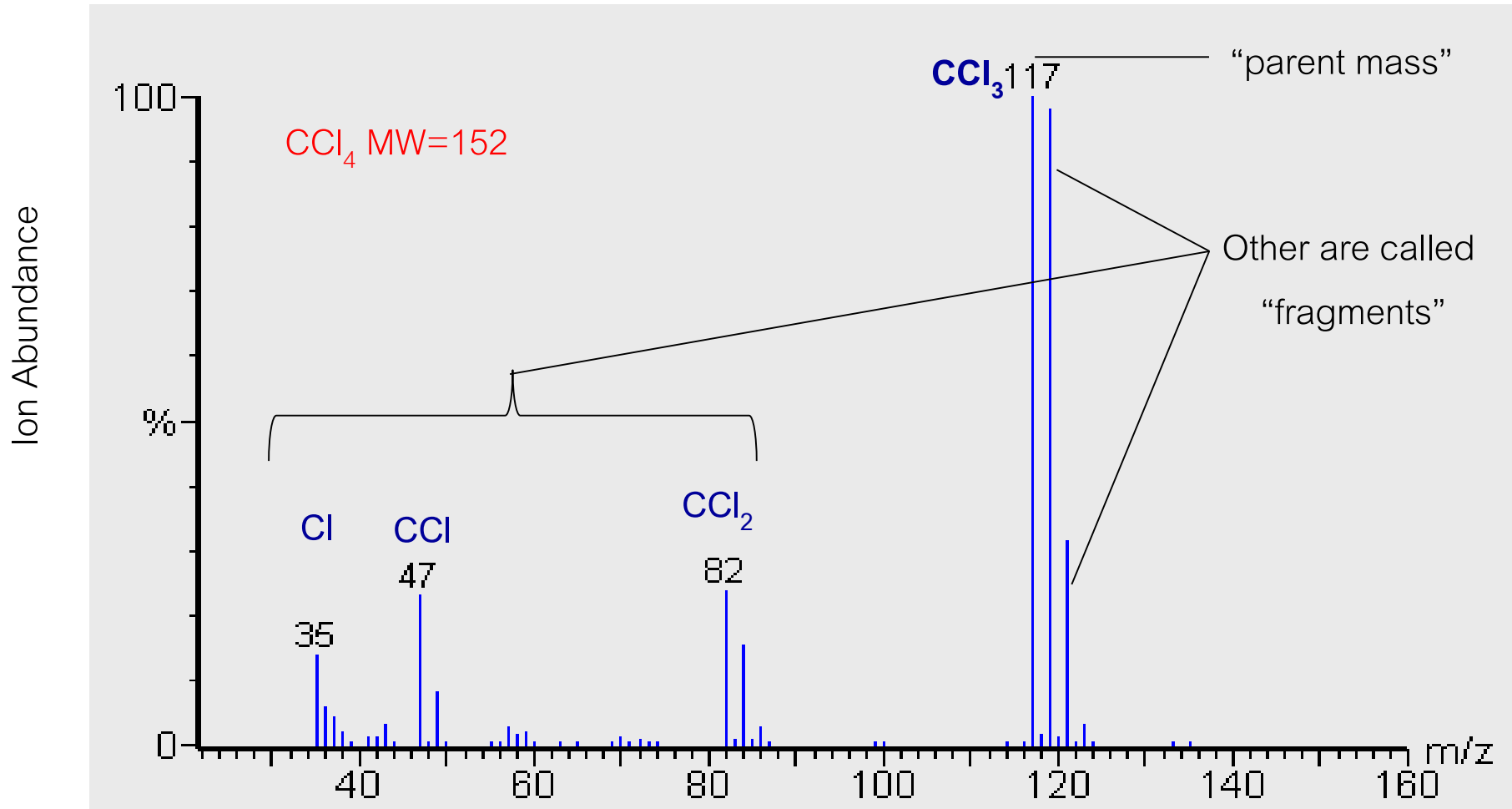

# Total Ion Chromatogram (TIC), Extracted Ion Chromatogram (EIC), and Mass Spectrum

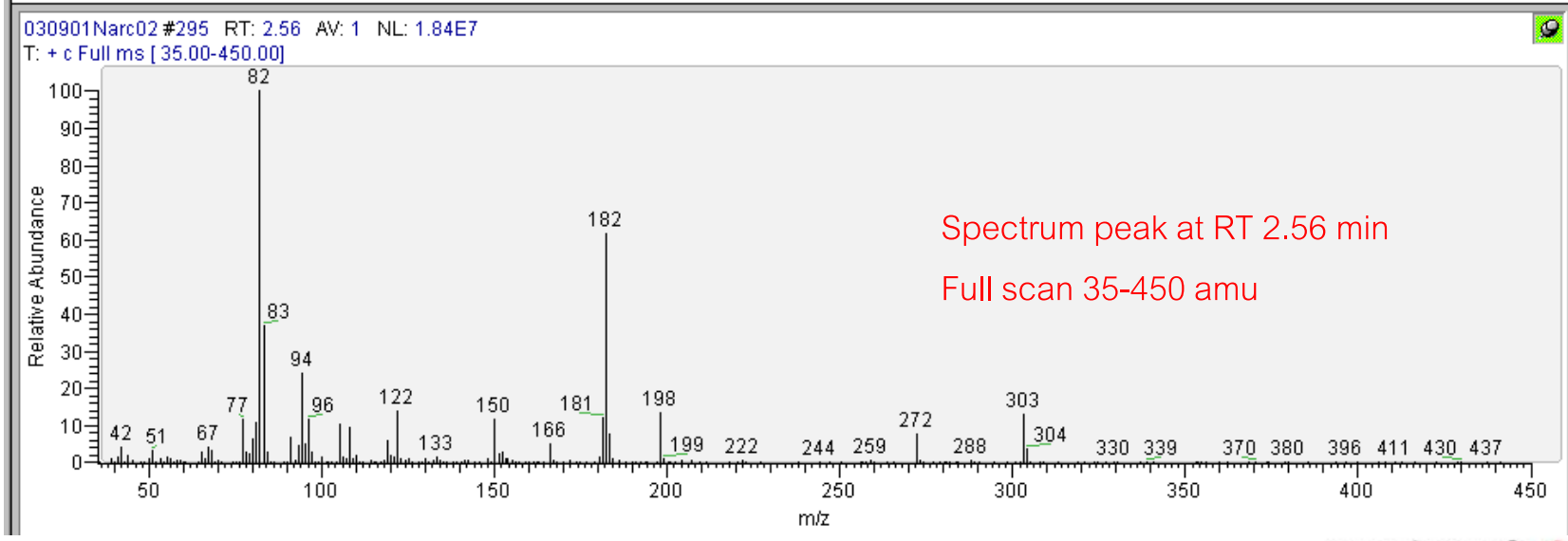
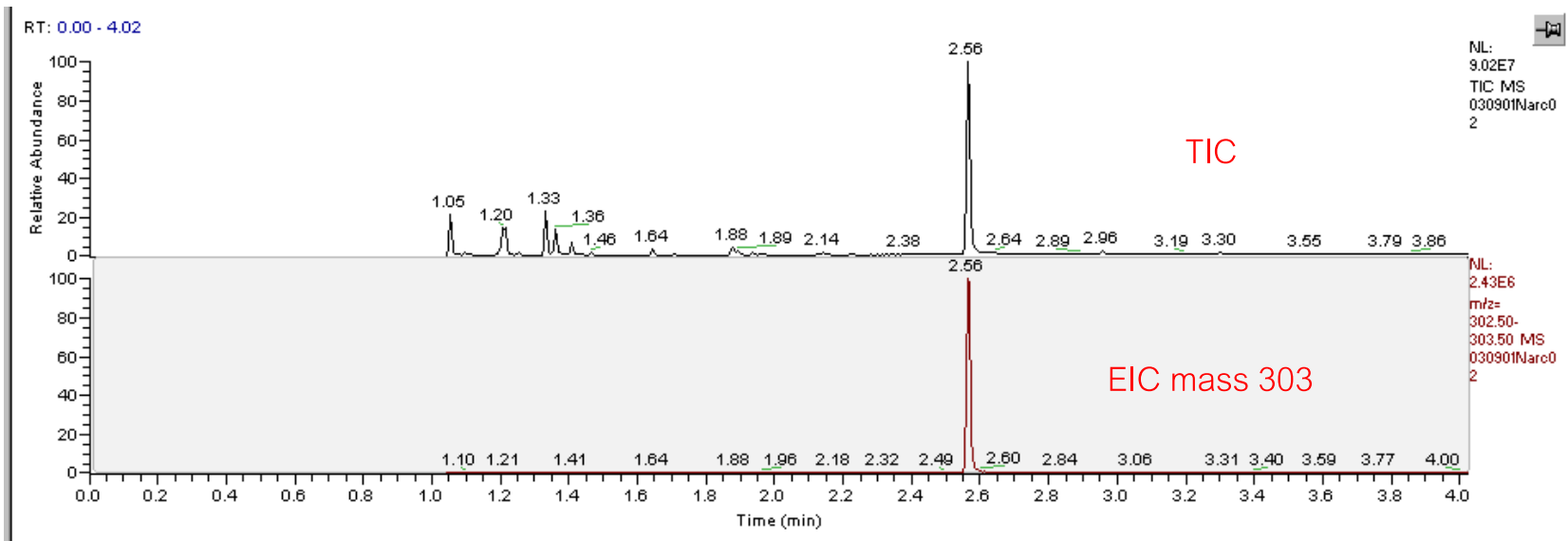

# Components in GC/MS

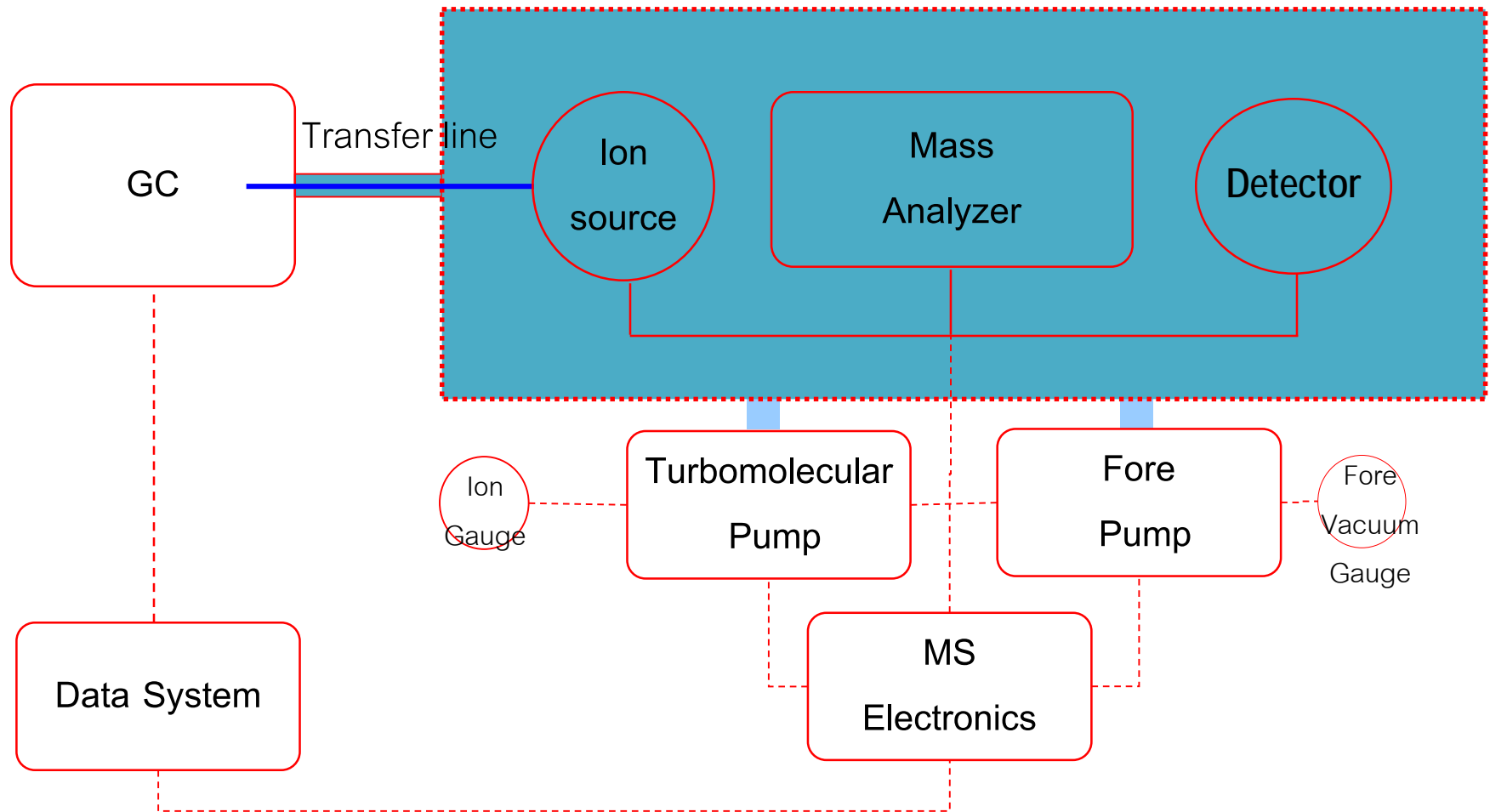

- “Bridge” between GC and MS’s Ion Source
- Vacuum tube with have heater coil on the internal tube.
- GC column is inserted inside the internal tube.
- High temperature (200-350 C) is set to protect sample condensation.
- Type
  - Direct capillary transfer line (most widely used) – GC column connect directly to ion source
  - Open/Split transfer line
  - Splitter transfer line
  - Jet separator

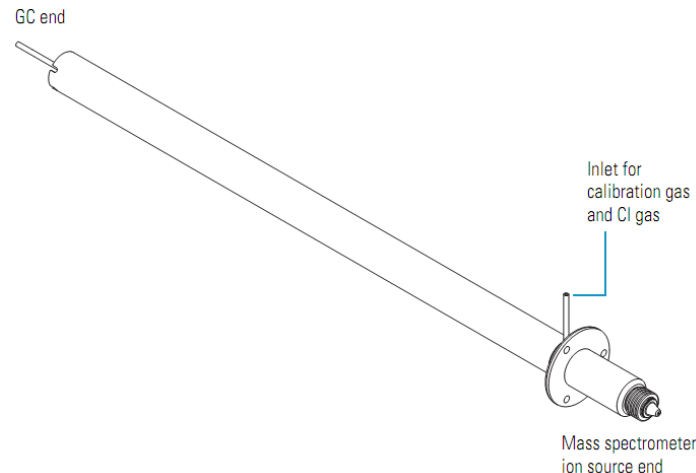

- Ion Source convert sample molecules (neutral) into charged molecules or molecular ions.
- Charged molecules (Molecular ions) can be easily manipulated with electrical and magnetic fields
- Process in mass spectrometer are using DC, RF to
  - Focusing : arrange the molecular ion to travel in a straight direction
  - Diverting : turn the direction of molecular ion
  - Filtering : get rid of unwanted molecular ion
  - Detecting : detect those interested molecular ion

# Ion Source Cartridge (iSQ)

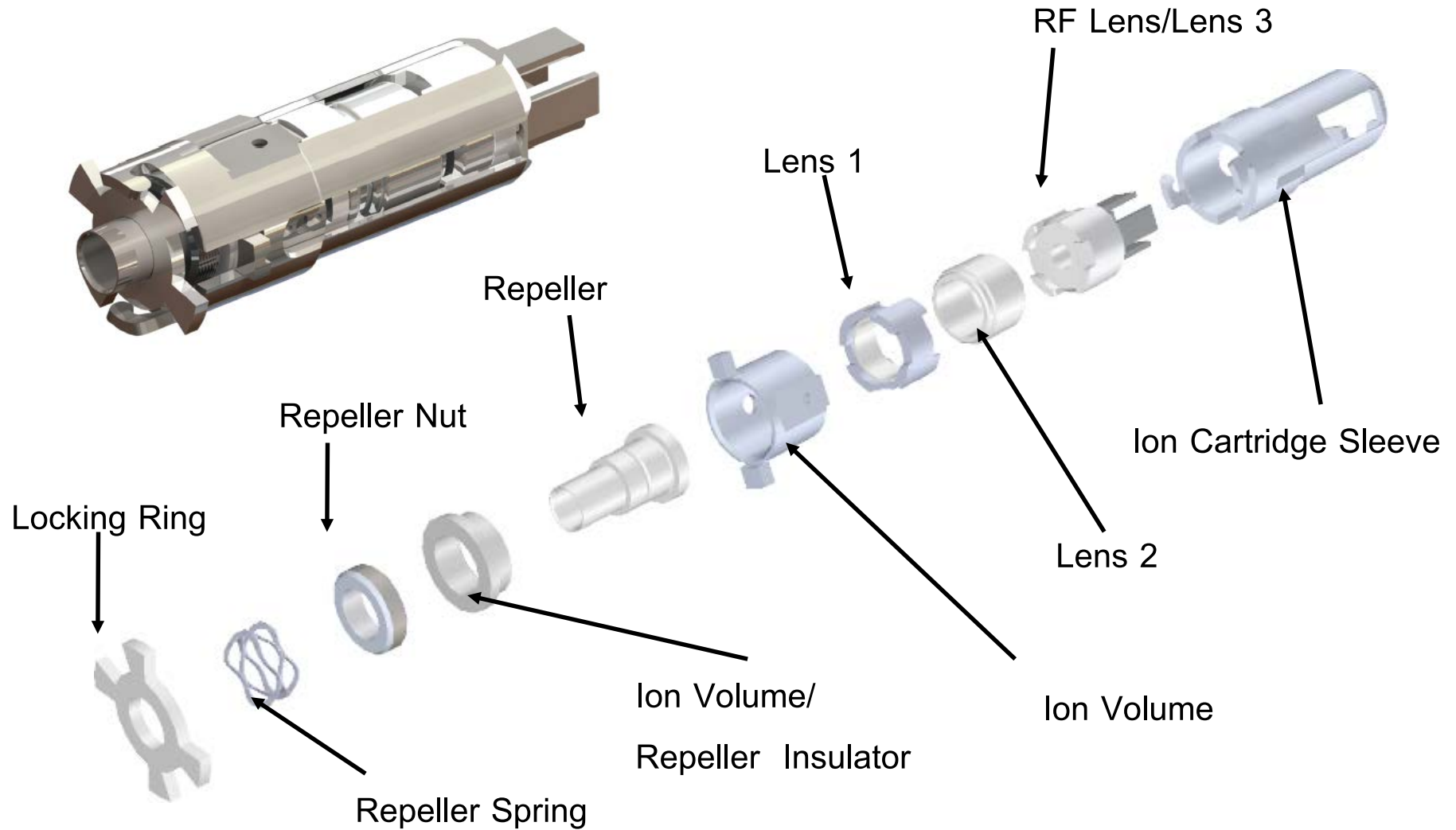

- Electron Ionization
- Chemical Ionization
  - Positive Ion Chemical Ionization
  - Negative Ion Chemical Ionization



# Electron Ionization

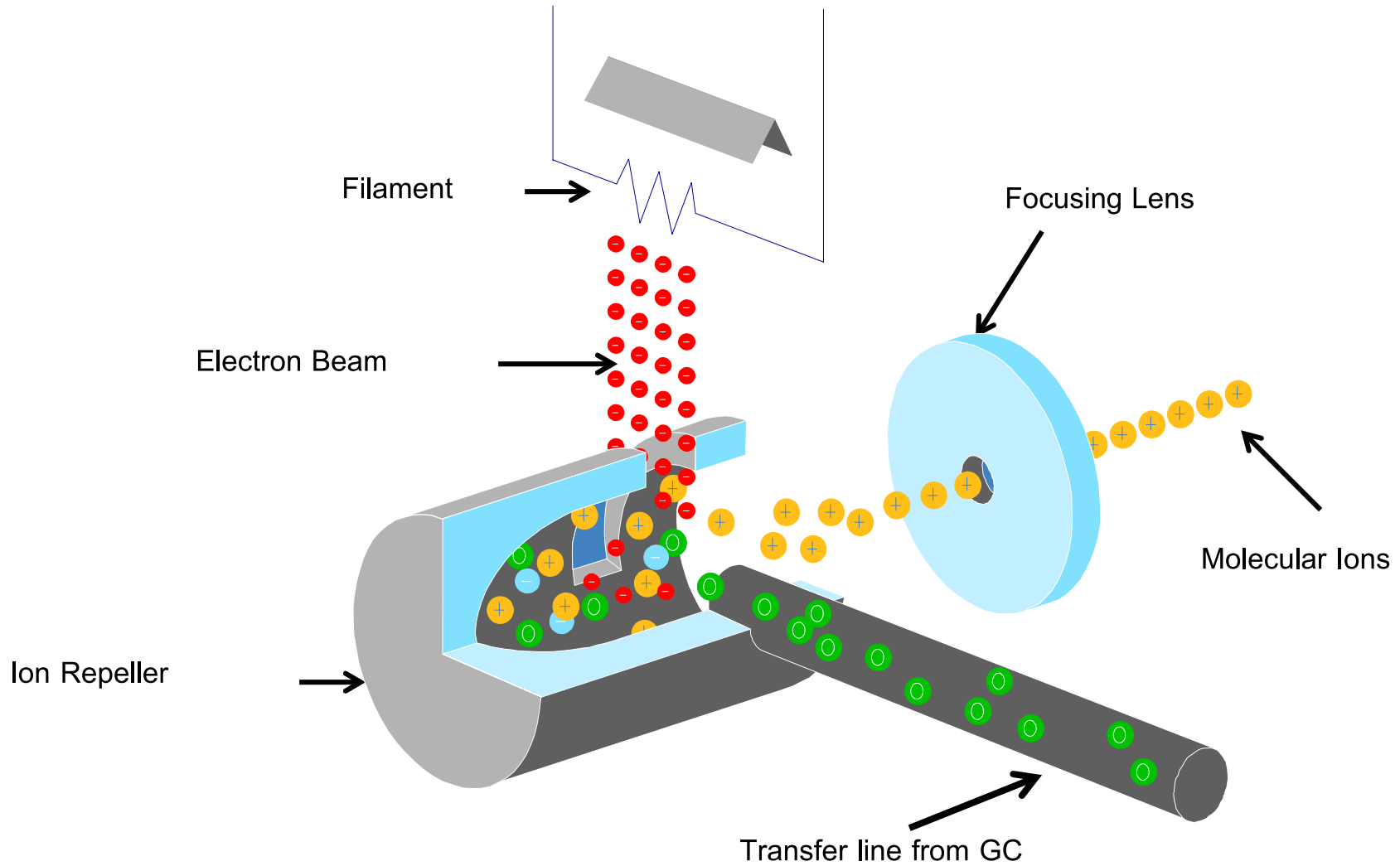

- Reagent gas reacts with electrons to form primary ions
- Primary ions react with  $\text{CH}_4$  and form collided ions
- Collided ions react with sample molecules (soft ionization) and form molecular ions
- Molecular ions present in form of  $[\text{M}+\text{H}]^+$ ,  $[\text{M}-\text{H}]^+$ ,  $[\text{M}+17]^+$ ,  $[\text{M}+29]^+$ ,  $[\text{M}+41]^+$
- Main use is molecular weight confirmation (clean spectra)
- Example of reagent gas :  $\text{CH}_4$ , Isobutane

# Adduct Formation in PICI

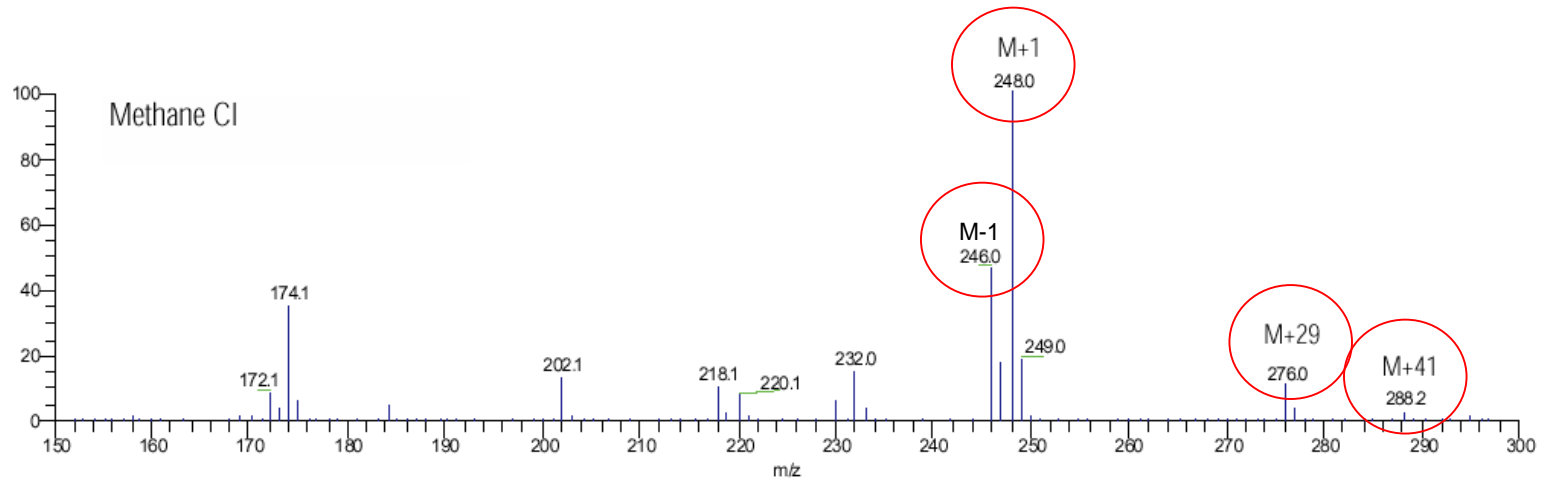
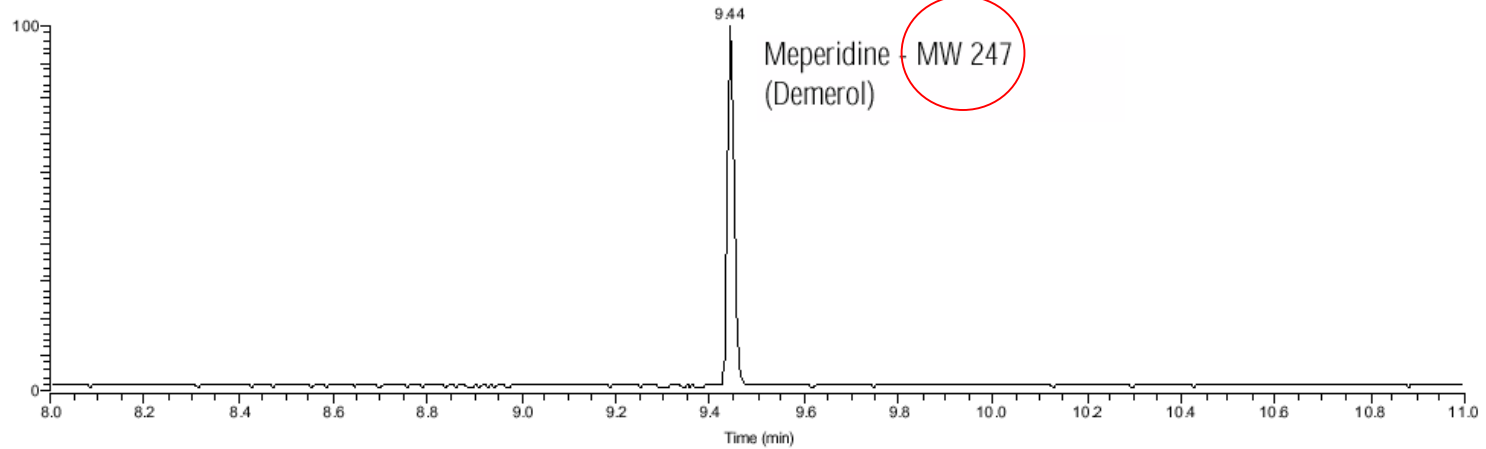

EI Spectrum of Heptachlor

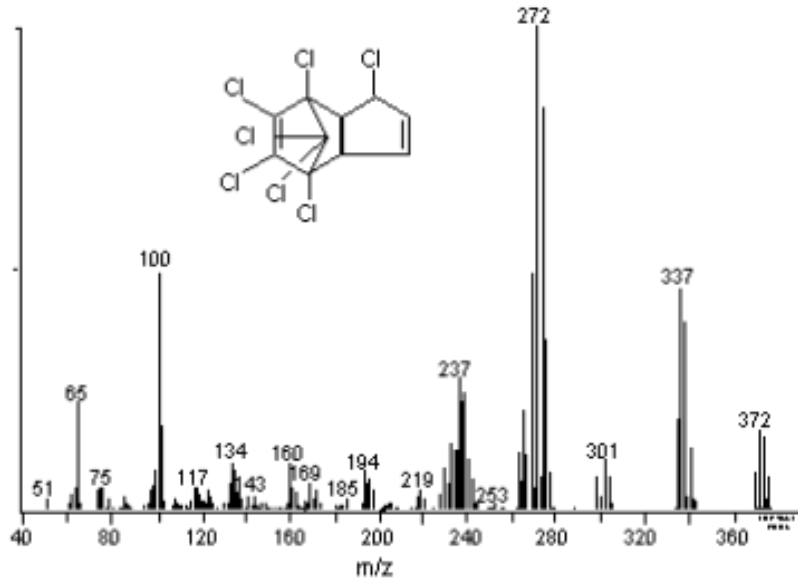

Intensity is low for any single m/z ion.

PCI Spectrum of Heptachlor

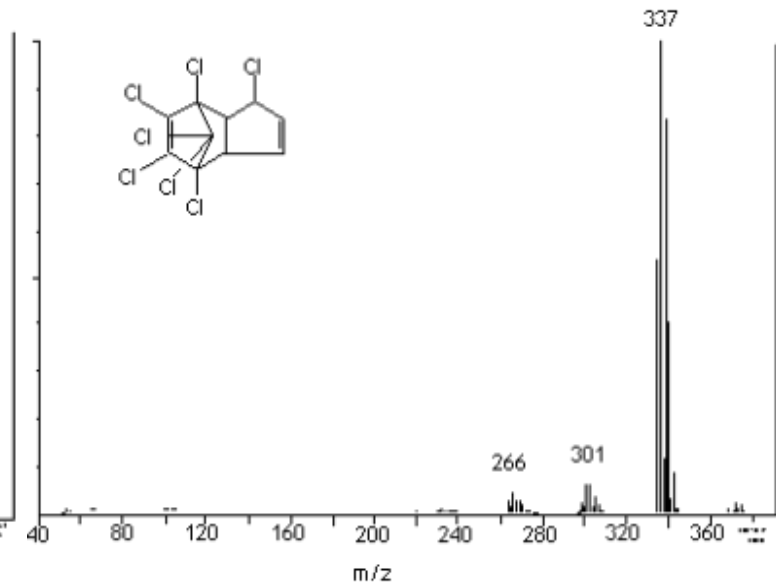

Intensity is concentrated in  $[M+H]^+$  ion.

Spectrum is simpler.

In PCI, sample is not fragmented. Therefore, PCI will provide higher ion intensity

Which means better detection limit when compares with EI

- Lens :
  - Applying appropriate voltage to lens can be used to induced molecular ions into certain distance and direction
- Multi-pole rods :
  - quadrupoles , hexapoles, octapoles are widely used to transmit ions for longer distance

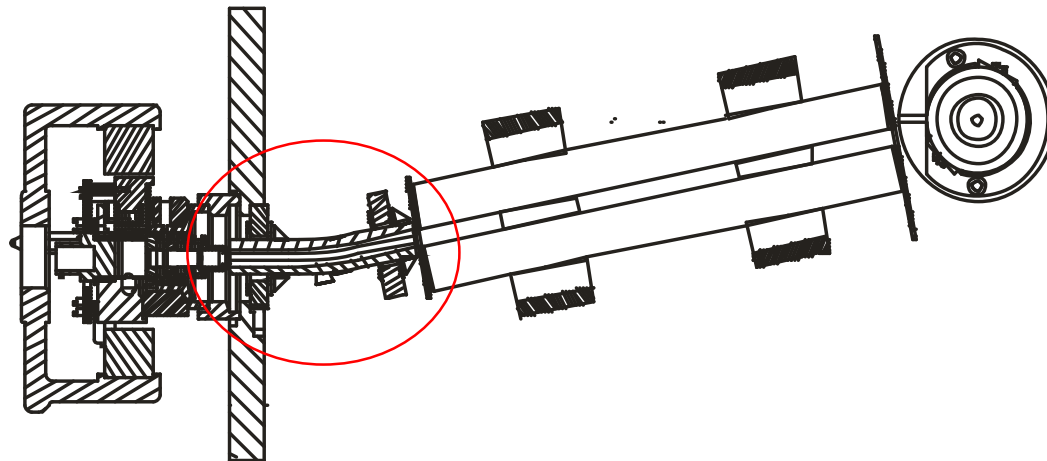

1. Quadrupole *or* Single Quadrupole
2. Ion Trap
3. Triple Quadrupole
4. Time of Flight (TOF)
5. Magnetic Sector
6. Orbitrap

# Single Quadrupole Mass Analyzer

Quadrupole - consists of two sets on opposing rods. This mass analyzer uses a combination of RF(AC) and DC modulation to sort ions. This analyzer provides nominal mass resolution

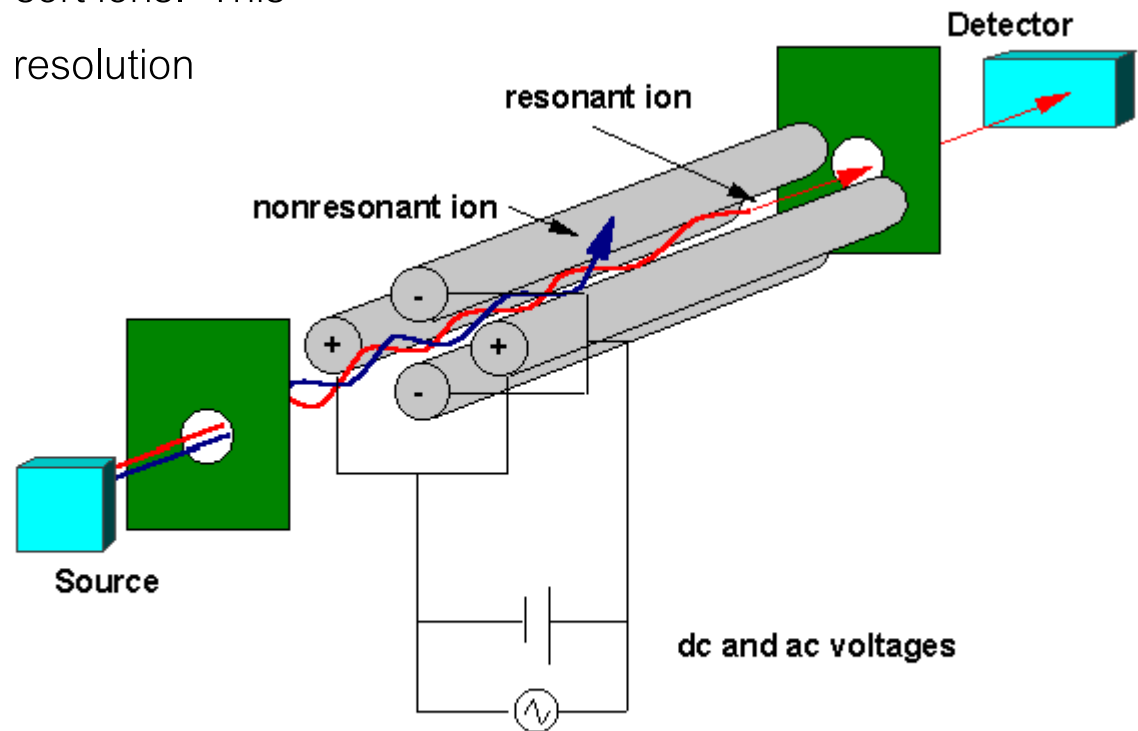

# Quadupole Mass Filter Operation

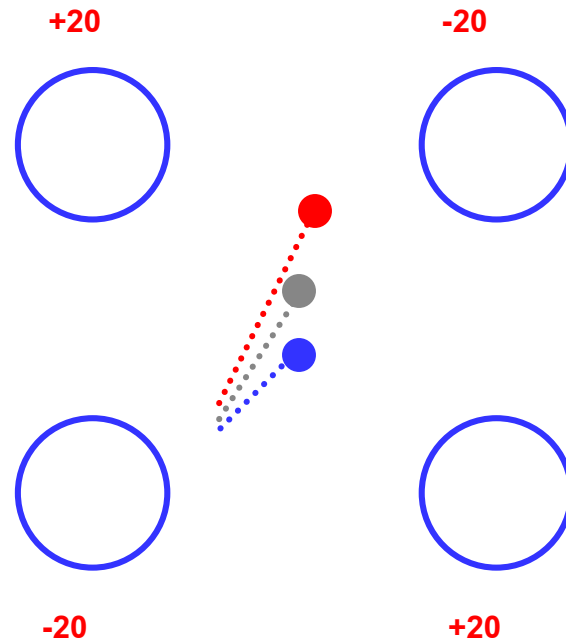





- m/z= 4+
- m/z= 100+
- m/z= 500+

At Time 0

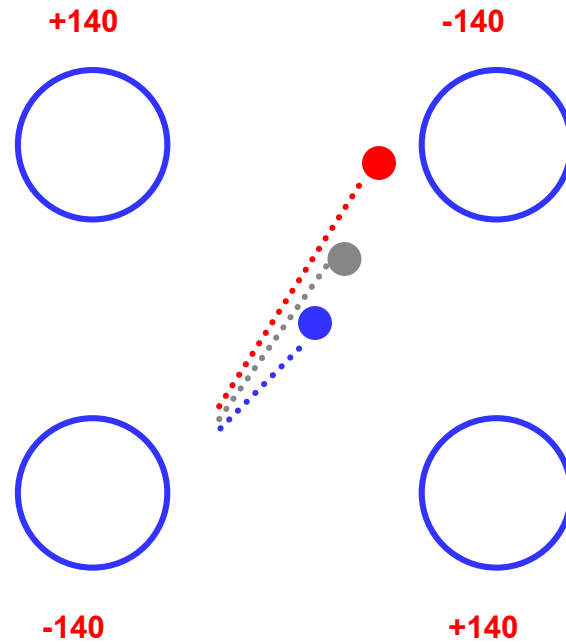

# Quadupole Mass Filter Operation



	m/z= 4+
	m/z= 100+
	m/z= 500+

At Time 1

# Quadropole Mass Filter Operation

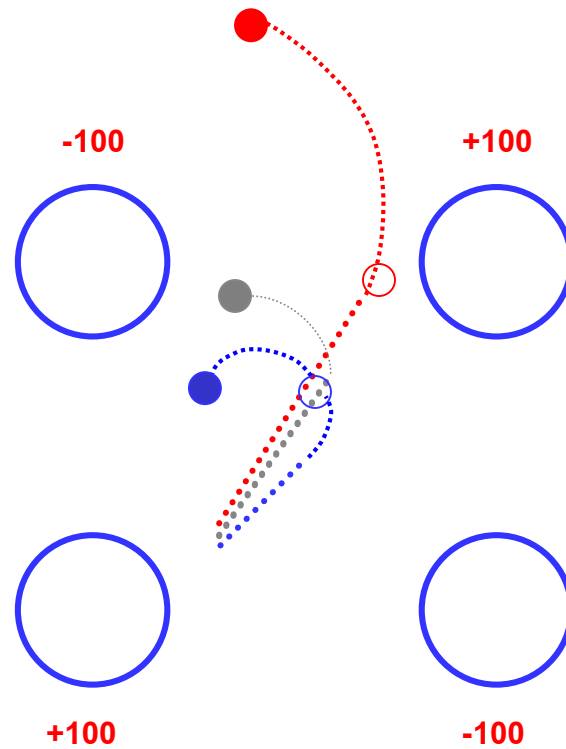

At Time = 2

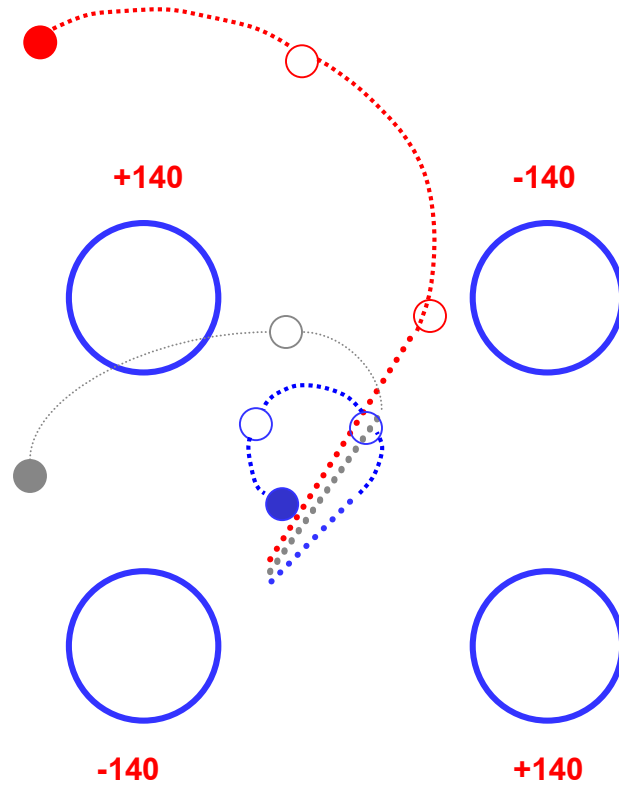

# Quadupole Mass Filter Operation

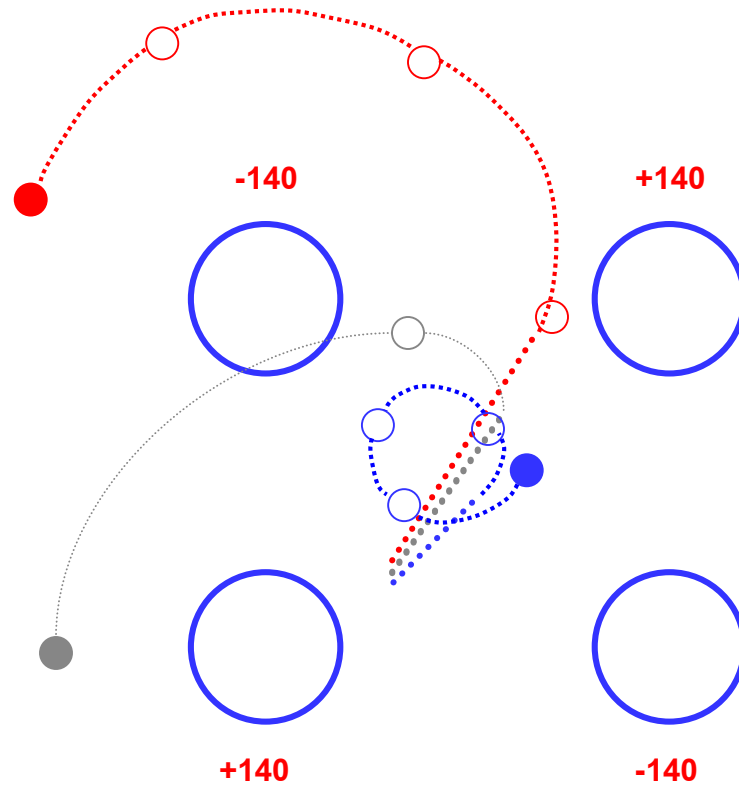

At Time = 3

# Quadupole Mass Filter Operation



	$m/z = 4+$
	$m/z = 100+$
	$m/z = 500+$

# Operation modes in Single Quad MS

- Full Scan
  - Set a mass range to cover sample's molecular ions
  - Get spectrum for identification
  - Good for unknown but Low sensitivity
- Selected Ion Monitoring (SIM)
  - Select one or a few molecular ions those will be monitored
  - Lost spectrum information
  - High sensitivity but may cause false positive error

# Ion Trap Mass Analyzer

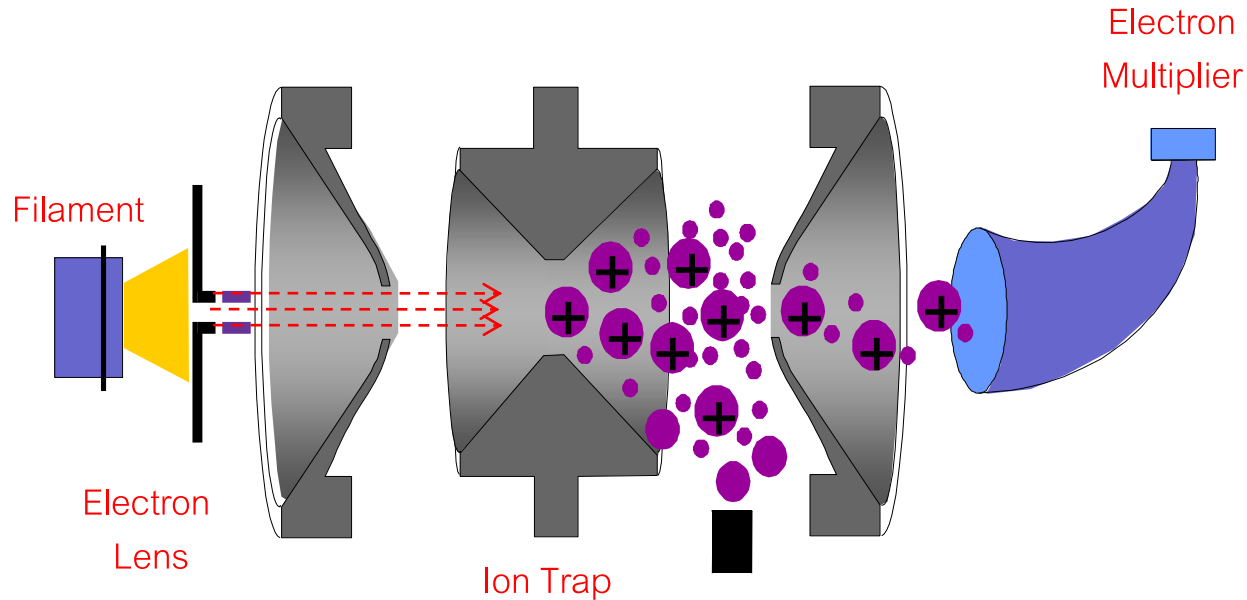

**Ion Trap** - operates on a principle as the quadrupole; however ions can be stored for subsequent analysis. The ions are sorted by changing the electric field inside of the trap by manipulating the RF field and sequentially ejecting the ions from low to high mass to charge.

# Full Scan in Ion Trap

Two steps in Full Scan

1. Ion injection into the trap
2. Ion detection

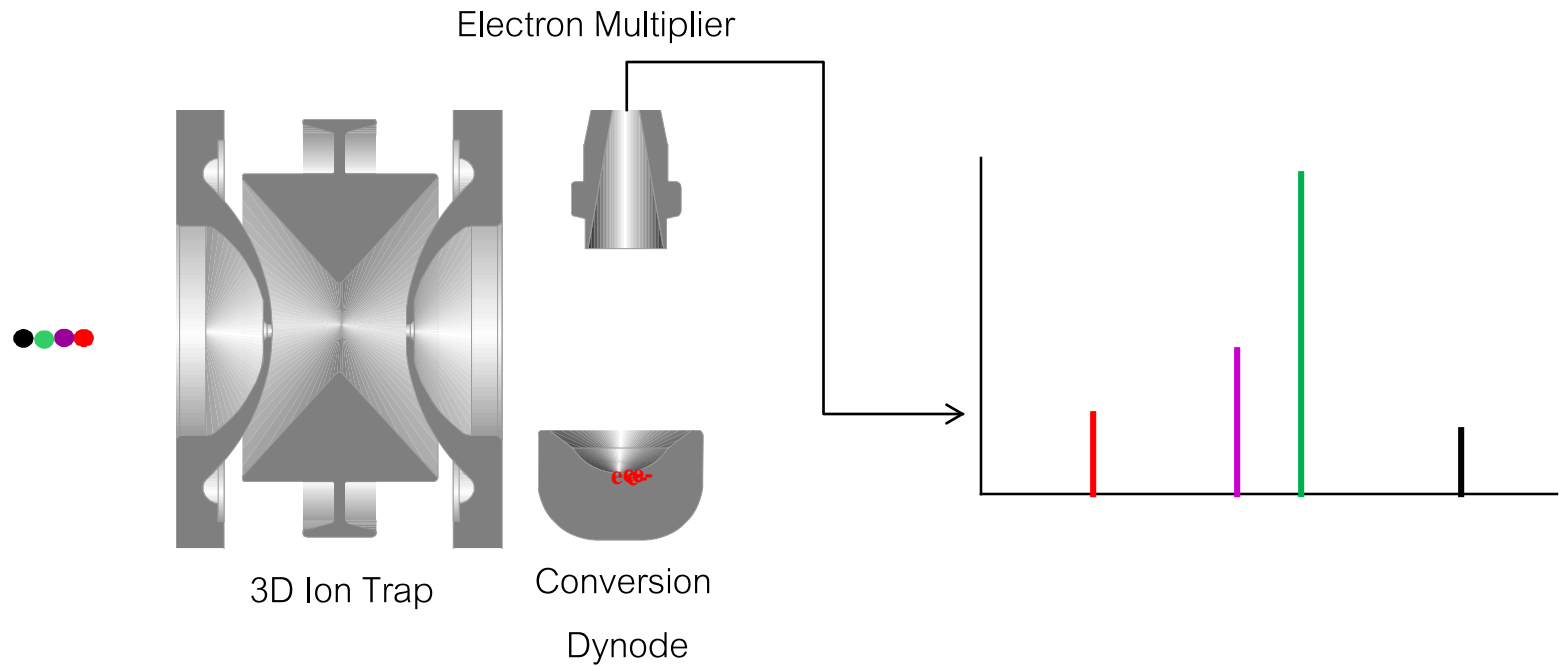

# SIM (Selected Ion Monitoring) in Ion Trap

Three steps in SIM

1. Ion injection into the trap
2. Ion isolation
3. Ion detection

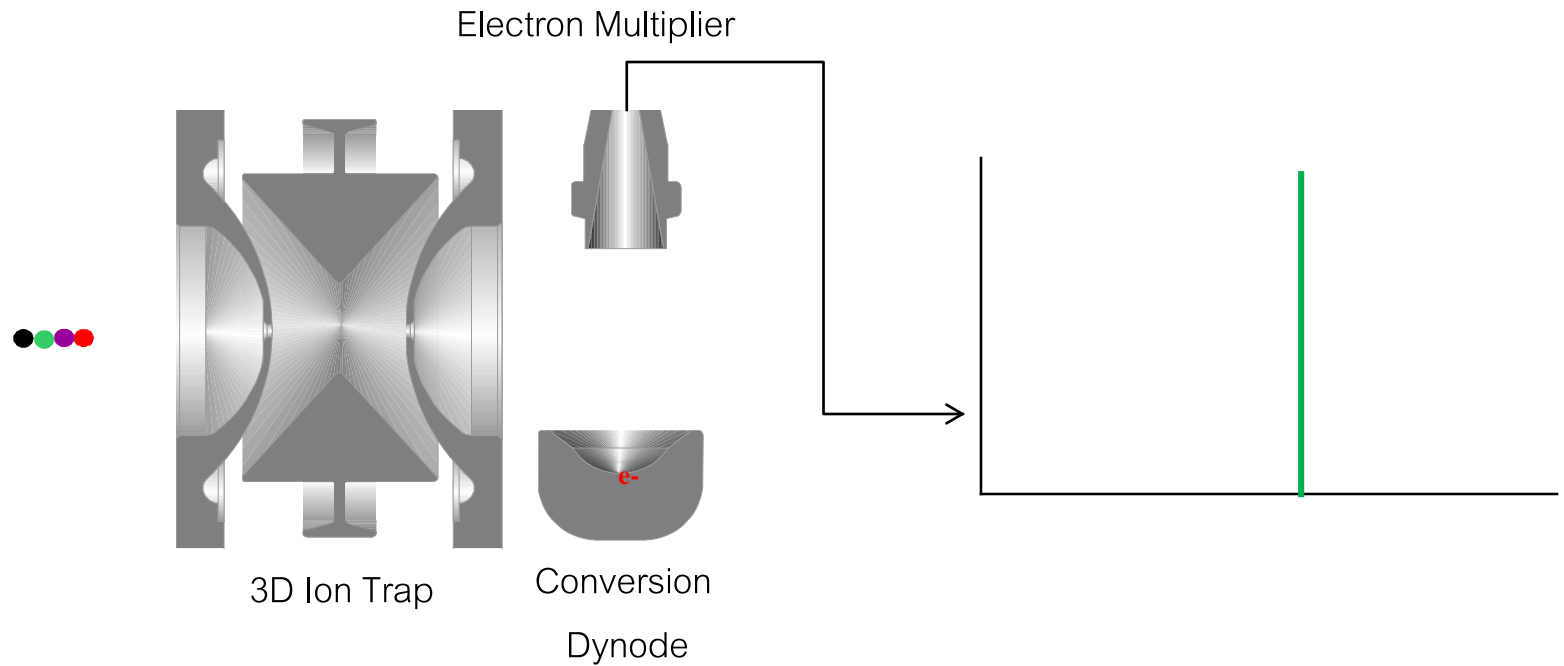



Four steps in MS/MS

1. Ion injection into the trap
2. Ion isolation (precursor selection)
3. Ion Fragmentation
4. Ion detection

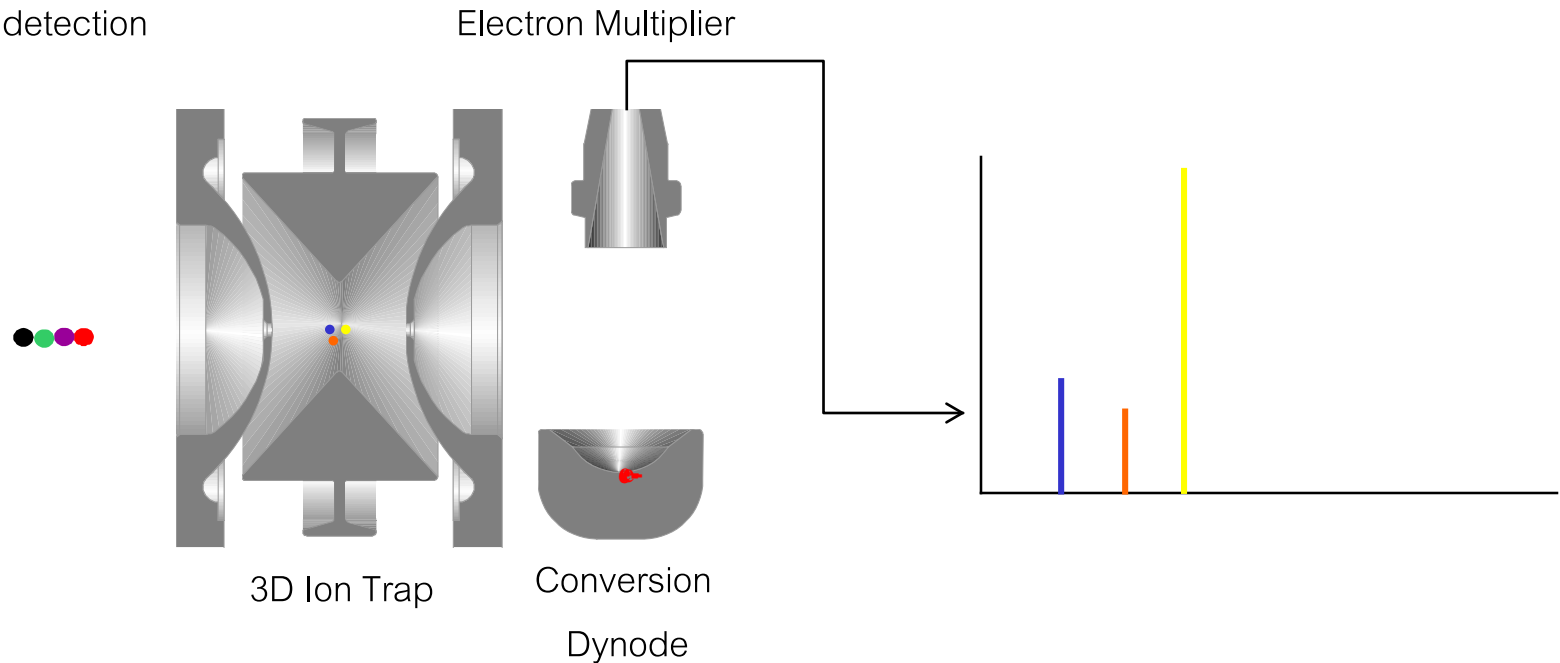

# MS/MS Example - Chlordane

GC/MS Spectrum

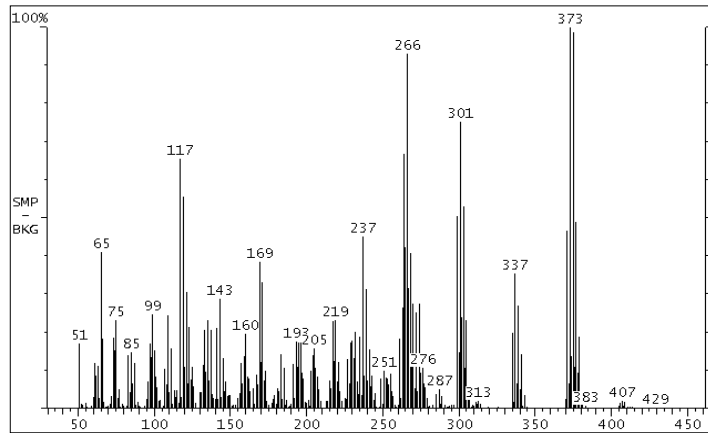

GC/MS/MS Product Ion Spectrum

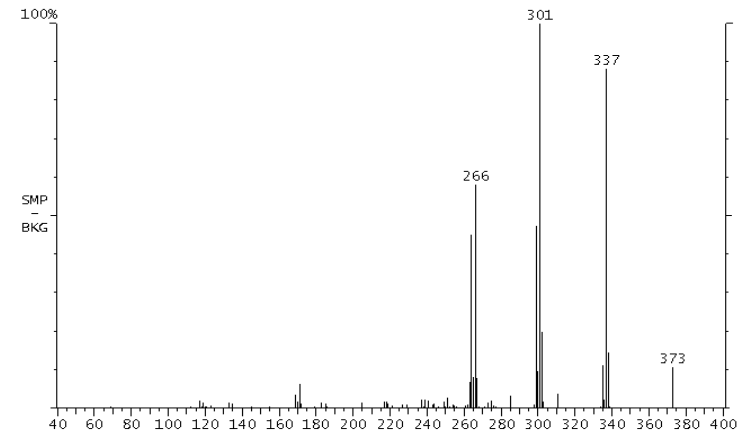

Isolation of  
Precursor Ion

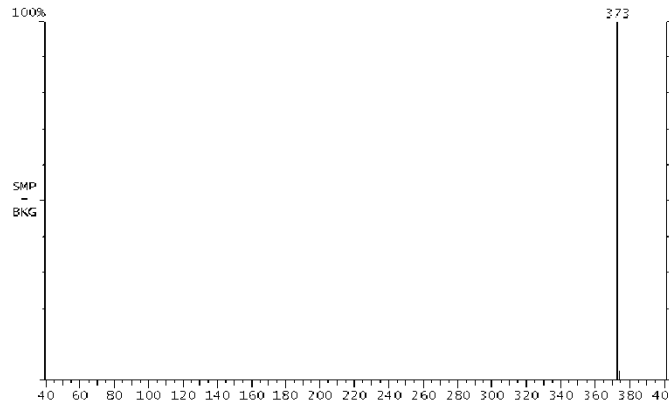

Fragment  
Precursor Ion

# Triple Quadrupole Mass Analyzer

- Triple Quadrupole - consists of two sets of quadrupole with one collision cell in between. This mass analyzer uses a combination of RF and DC modulation to sort ions just like single quadrupole. Q1 and Q3 work like mass filter (using RF and DC) while Q2 works as a Collision cell (RF only and Collided gas). Q1 can selected any precursor (parent mass) and pass it into collision cell (Q2) where precursor are fragmented and pass through Q3 for ion sorting again. This analyzer provides high sensitivity with fast confirmation analysis.

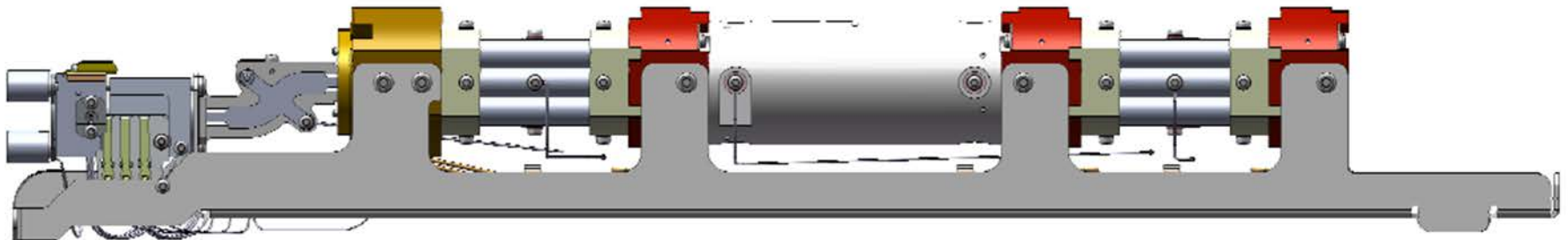

# Selected Reaction Monitoring (SRM or MRM)

Quantitation of target compounds in matrix samples

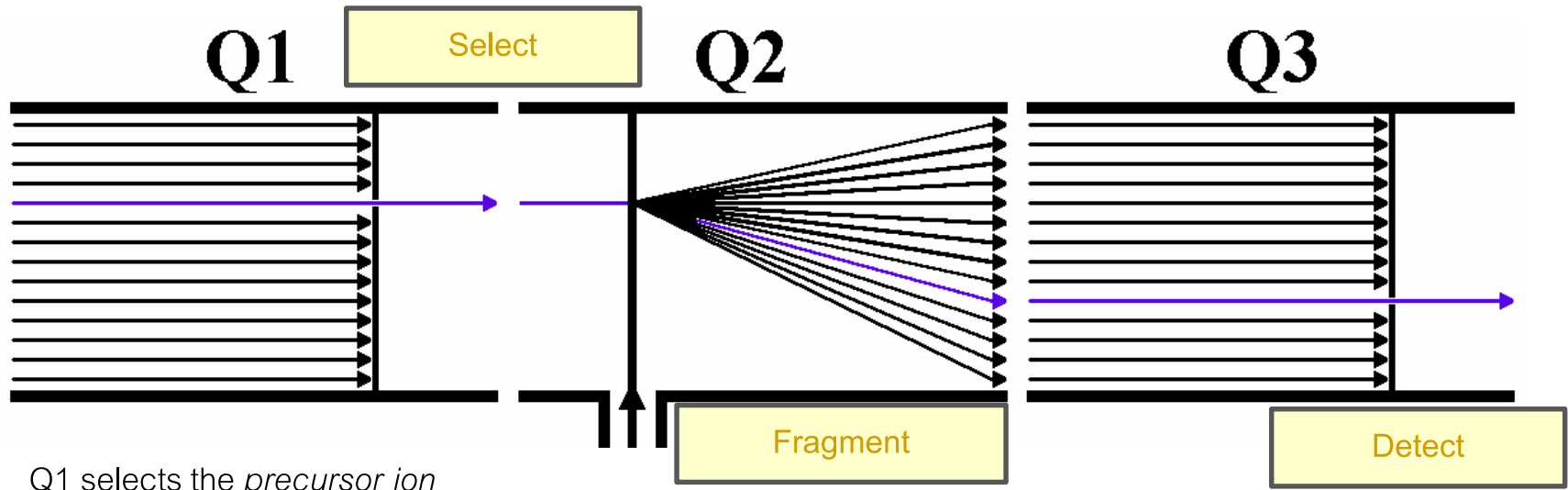
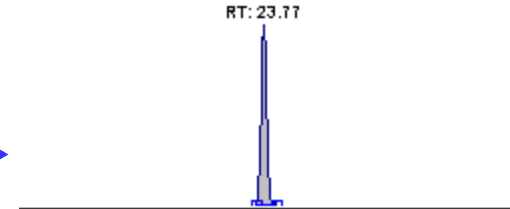
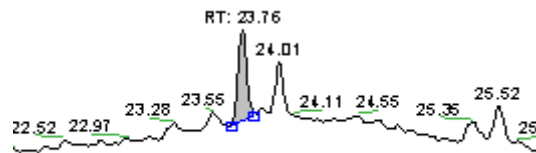

Q1 selects the *precursor ion*

Argon Collision Gas

Q3 selects the *product ion*

# Structure Specific Selectivity by QQQ : Parathion-Ethyl

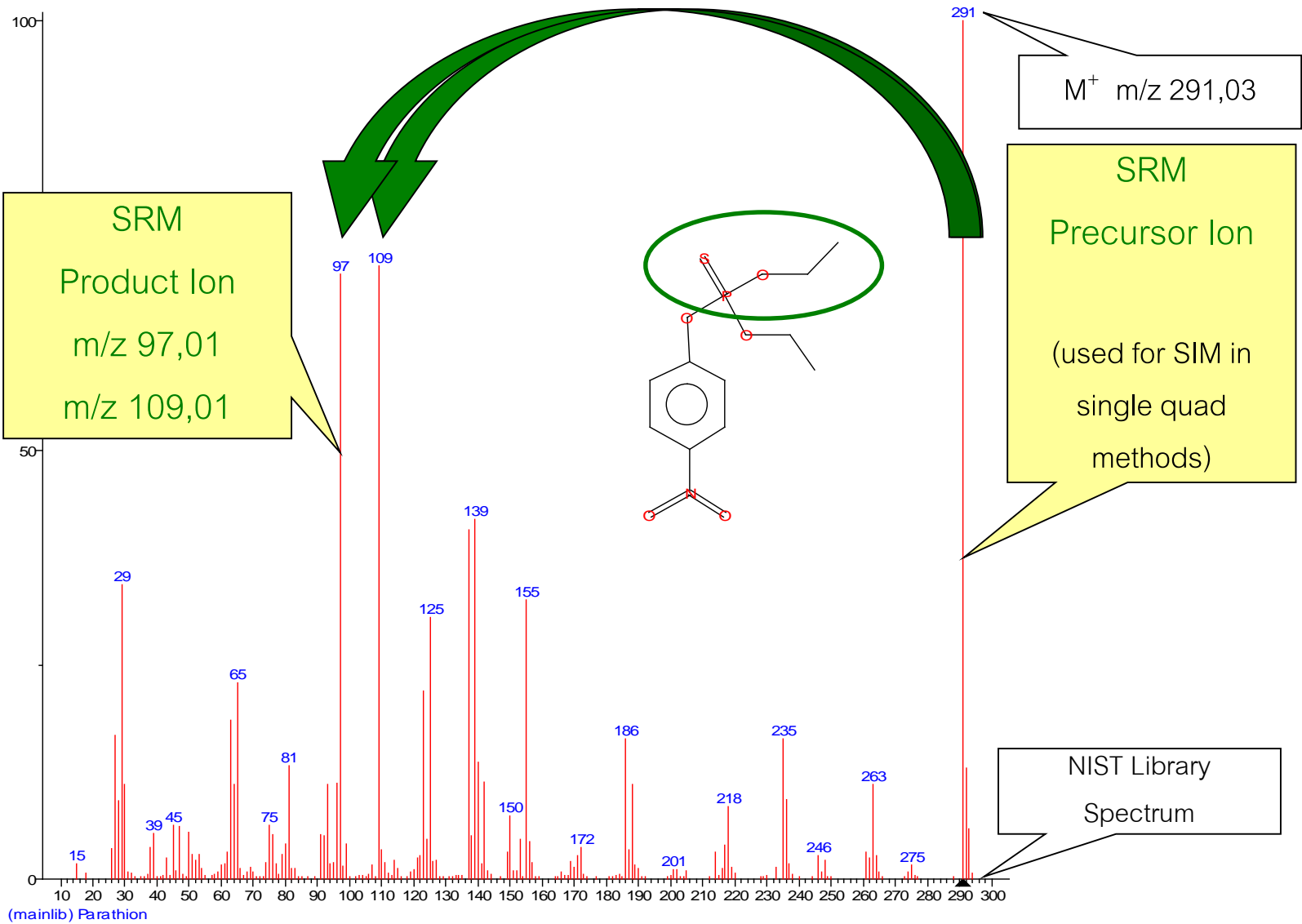

# Full scan/SRM Acquisition

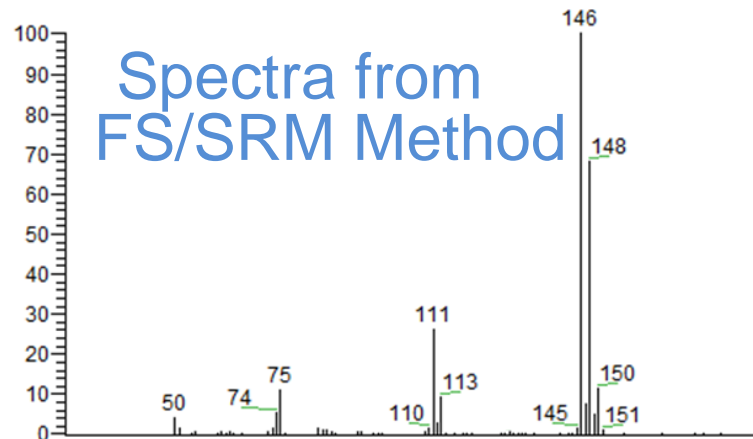
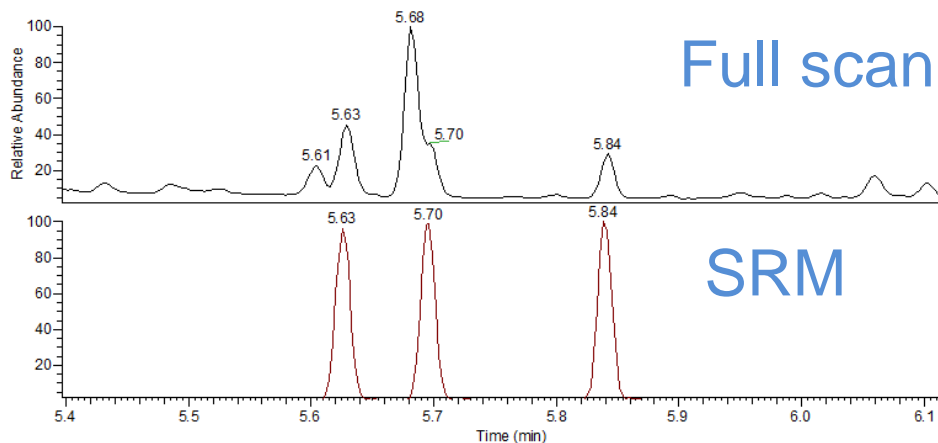

1\_000CurveLancaster350S1R9 #12135 RT: 5.84 AV: 1 SB: 5 6.08-6.09 NL: 1.54E8  
F: + c EI Full ms [50.000-550.000]

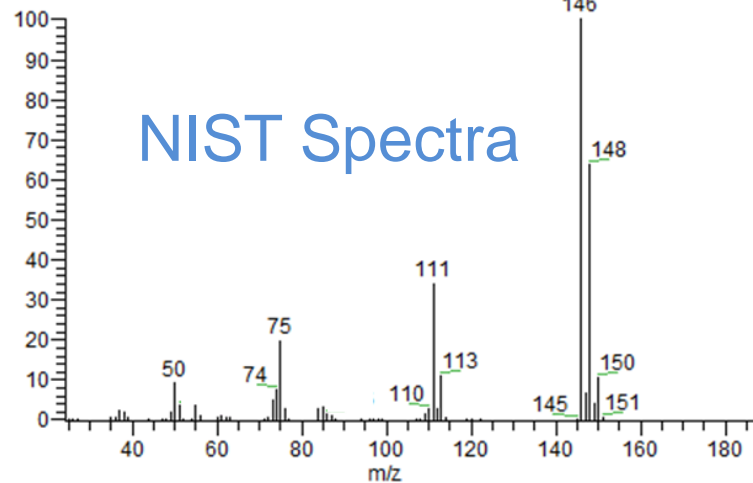
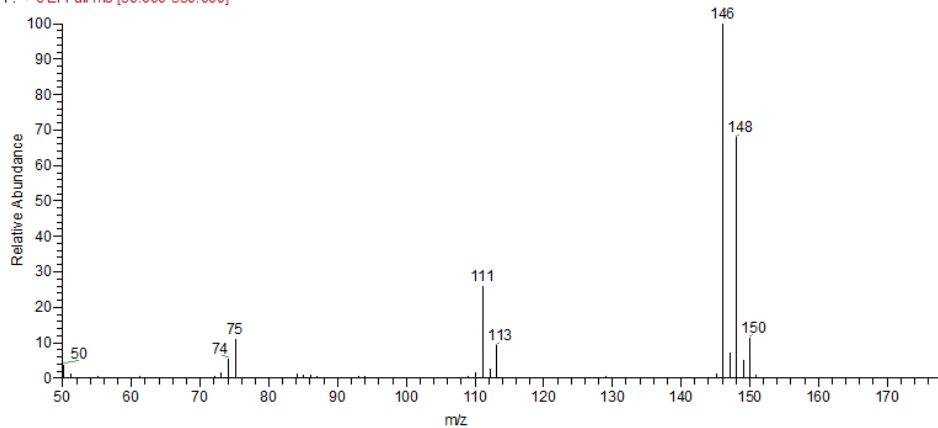

# Detector : Dynode Electron Multiplier

- Dynode converses Molecular ions into electron
  - Continuous Dynode
  - Discrete Dynode
- Electron are then sent to multiplier for signal enhancing

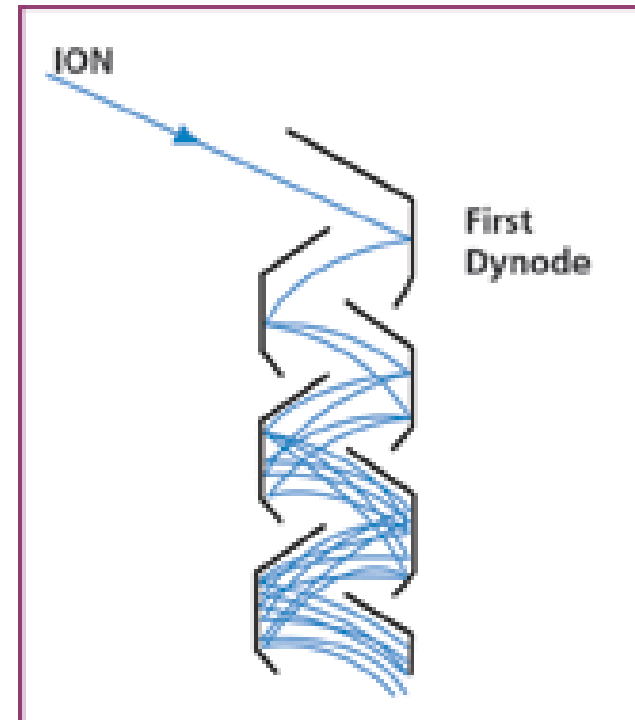
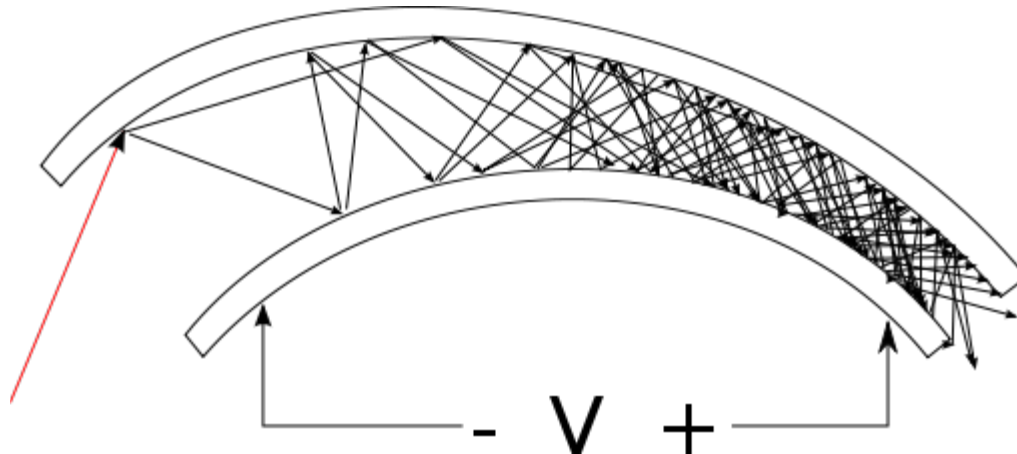
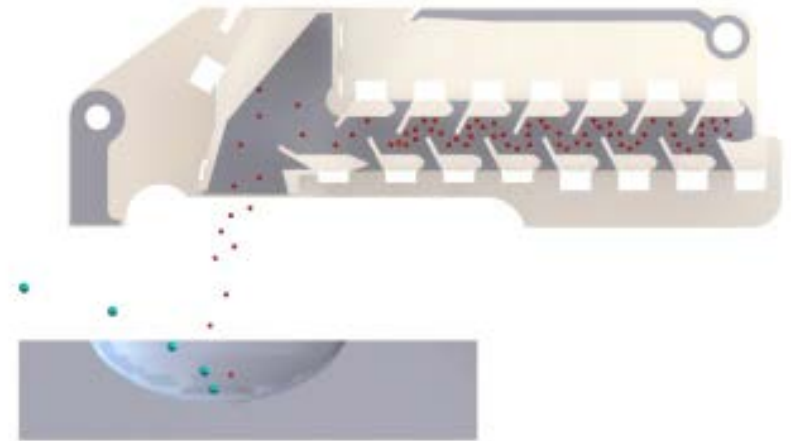

Photo courtesy from SGE & ETP, Wikipedia

- Off axis dynode
  - High voltage is applied (+/-10 KV) for high signal (accelerate ion velocity from mass analyzer to dynode)
  - Induces only molecular ions to hit dynode
- Electrons from dynode hit internal wall of EM.
- Multiplication process amplifies for more signals

## Electron Multiplier



## Dynode



- High Vacuum Pumps ( $10^{-3}$  to  $10^{-10}$  Torr)
  - Oil Diffusion
    - No moving parts
  - Turbomolecular
    - Clean - no oil
- Mechanical Backing Pump, (Fore Pump) (atm. to  $10^{-3}$  Torr)
  - Rotary vane

# GC & GC-MS Product Portfolio



<b>TRACE 1300 Series</b>	<b>ISQ Series GCMS</b>	<b>TSQ Series GCMS &amp; MS/MS</b>	<b>Exactive GC Q Exactive GC</b>	<b>DFS GC-HRMS</b>
Laboratory GC Multiple detectors and inlets	Single Quadrupole MS	Triple Quadrupole MS	Hybrid Quadrupole – Orbitrap GC-MS & GC-MS/MS	Double focusing Magnetic sector
Detection with Multiple Detectors	Confirmation by Mass Spectrum or SIM	High speed and high capacity MS/MS and SRM	High Resolution and Accurate Mass Full scan and MS/MS	High resolution selected ion recording (SIR)
General organics, pollutants, purity assays,	EPA Regulated Methods (524, 525, 8260, 8270)	Target Analysis requiring ultimate sensitivity/selectivity	Simultaneous quantitative and qualitative analysis with high selectivity	High Resolution targeted quantitation and general analytical work
QA/QC, Petro, Toxicology, Environmental	Environmental, general organic, forensic chemistry and toxicology	Food Testing, Environmental, Antidoping, steroids analysis	Food safety, environmental, 'omics, industrial, forensic tox, doping, pharma	Persistent organic pollutants (POPs), sports doping, petrochem

